



MINECRAFT

21242





LEGO.com/sustainable-packaging



BUILDER



Apple and the Apple logo are trademarks of Apple Inc., registered in the U.S. and other countries and regions. App Store is a service mark of Apple Inc. Google Play and the Google Play logo are trademarks of Google LLC. Tencent and the Tencent logo are trademarks of Tencent Inc.

Q [LEGO.com/devicecheck](https://www.lego.com/devicecheck)

EN Ask parents' permission before going online | DE Eltern um Erlaubnis bitten, bevor du online gehst | FR Demande l'autorisation d'un parent avant d'aller en ligne | IT Chiedi il permesso ai tuoi genitori prima di andare online | ES Pídeles permiso a tus papás antes de conectarte a Internet | PT Peça autorização aos pais antes de acederes online | JA オンラインになる前に ほかの方のきよかもをもらおう | ZH 上网前应先征得父母的同意 | KO 온라인 접속 전에 보호자 동의가 필요합니다 | RU Спроси разрешения у родителей, прежде чем заходить в интернет | PL Poproś rodziców o zgodę, zanim wejdiesz do Internetu | CS Než půjdeš na internet, požádej rodiče o svolení | SK Skôr než pôjdeš na internet, vypýtaj si povolenie od rodičov | HU Kérj szülői engedélyt, mielőtt online csatlakoznál! | RO Cere permisiunea părinților înainte de a te conecta online | BG Поискайте разрешение от родител, преди да влезете онлайн | LV Pirms došanās tiešsaistē palūdz atļauju vecākiem | ET Enne Interneti kasutamist küsi vanematelt luba | LT Prieš prisijungdami prie interneto, atsiklauskite tėvų

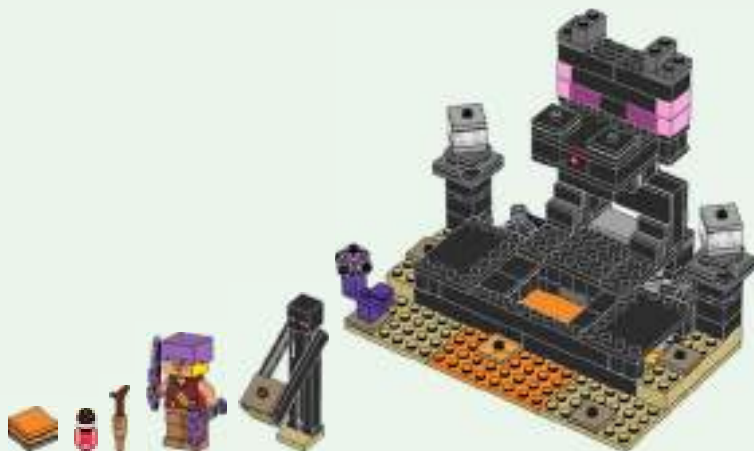
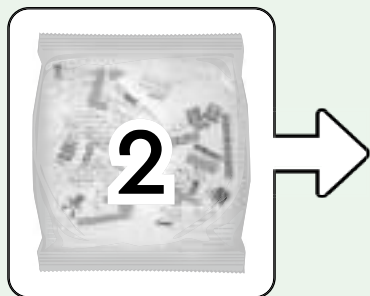
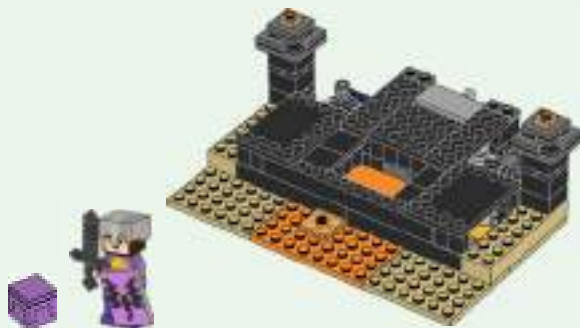
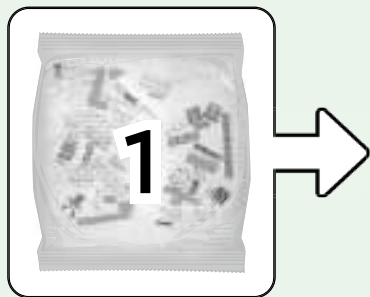

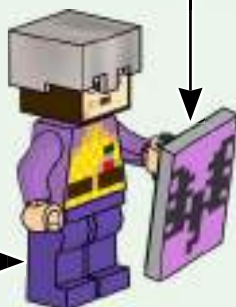
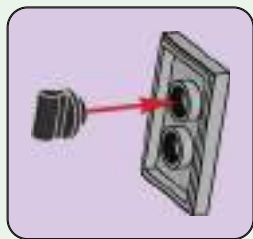
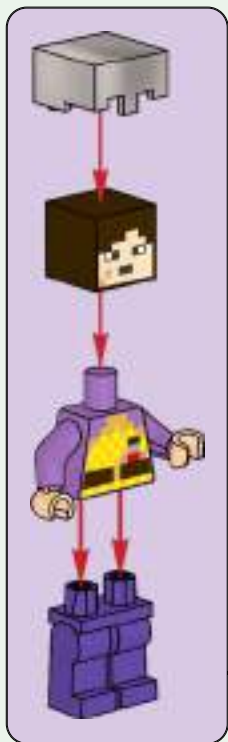

1



2



3



4

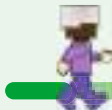
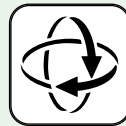

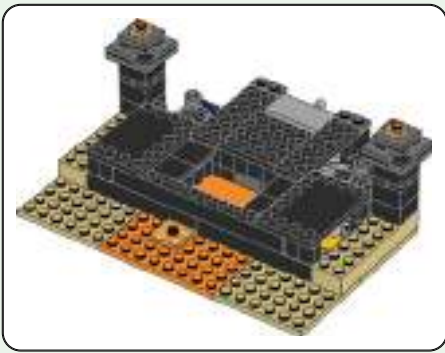

1

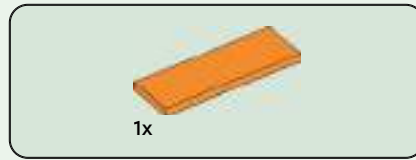

2

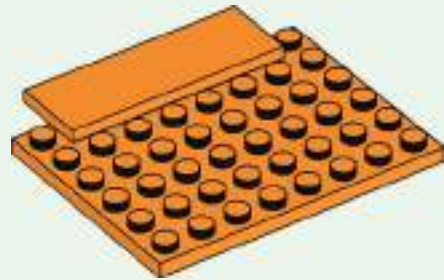

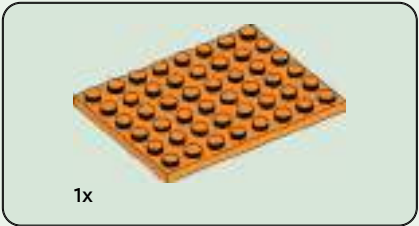

3

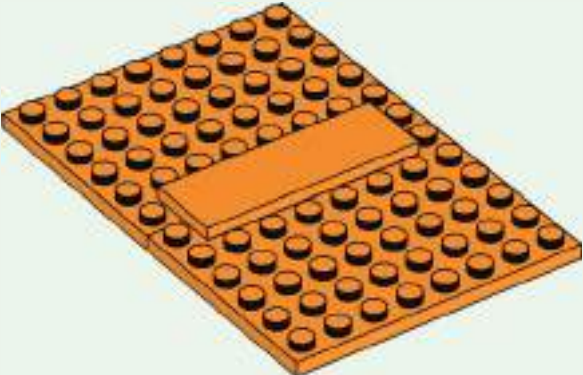



4

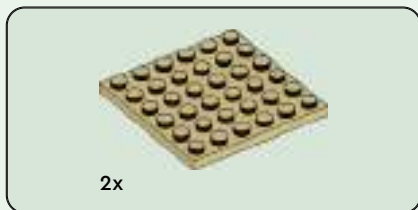
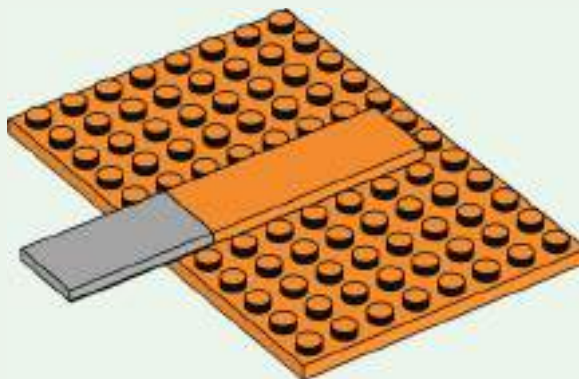

5

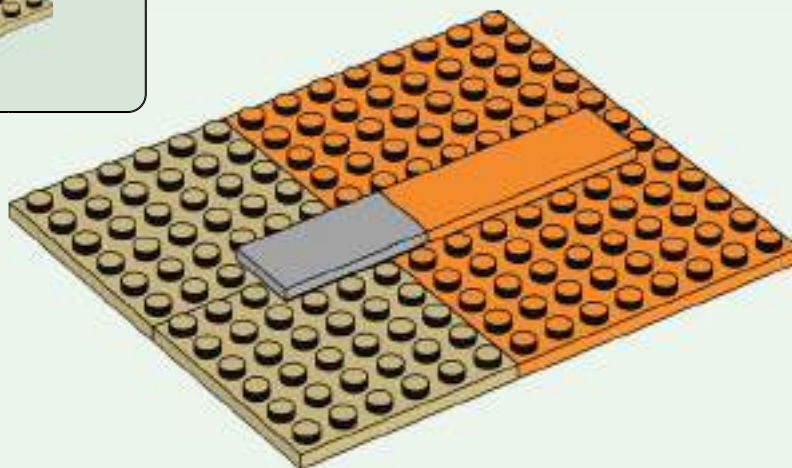



1x

6

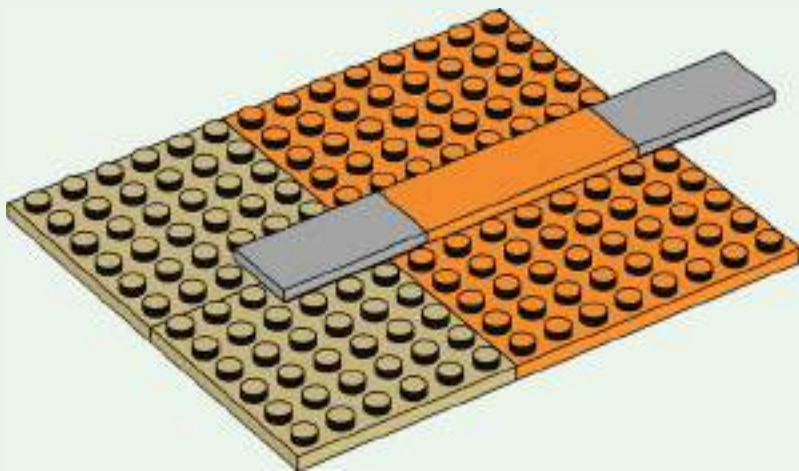

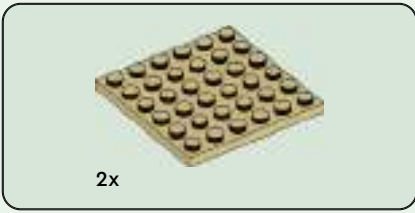

7

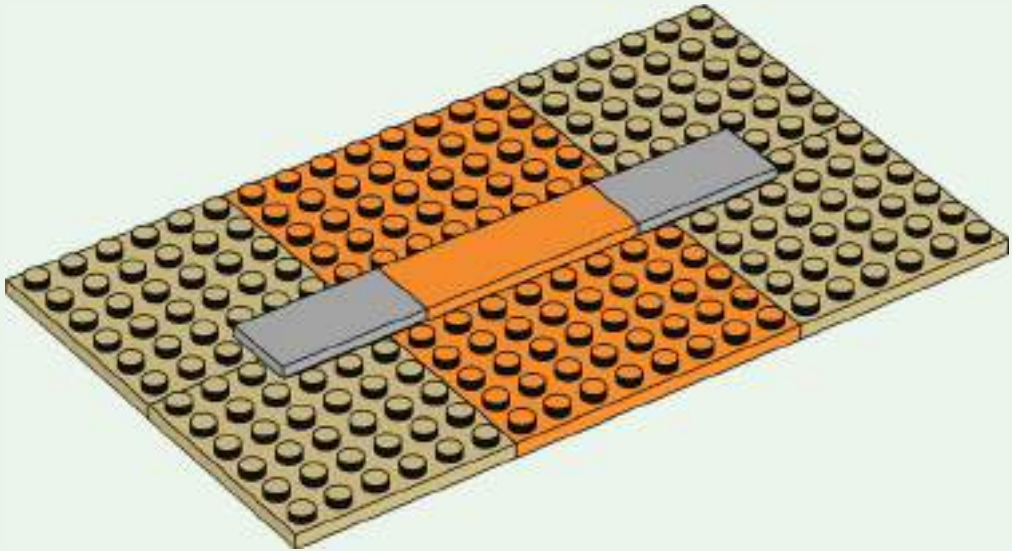

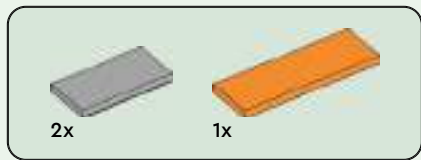

8

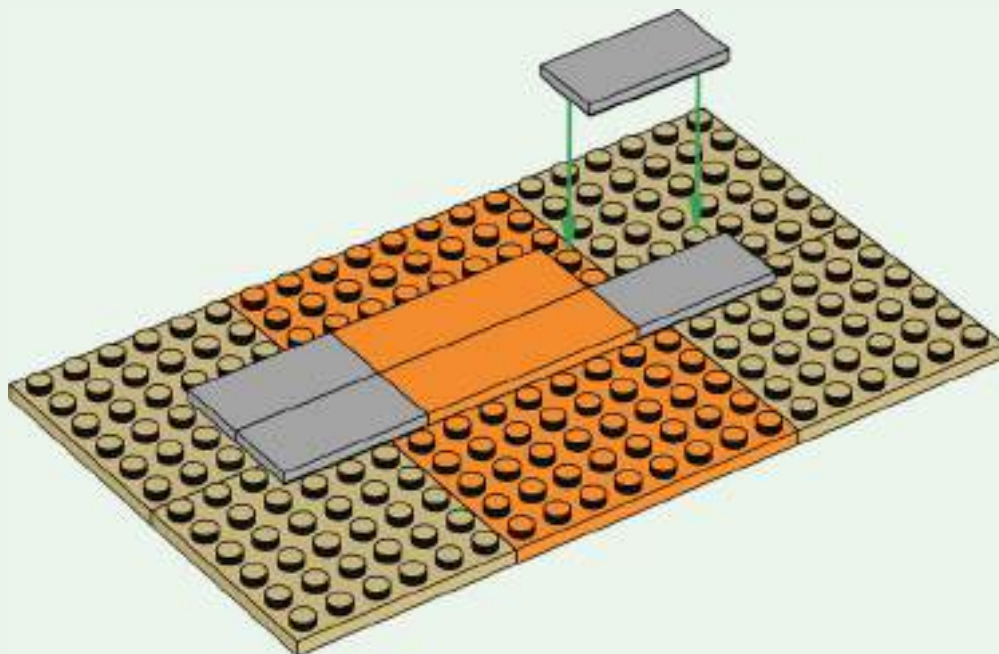

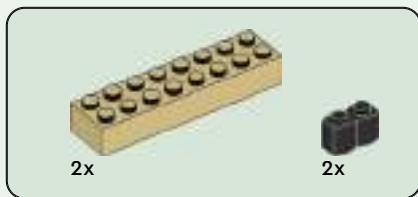

9

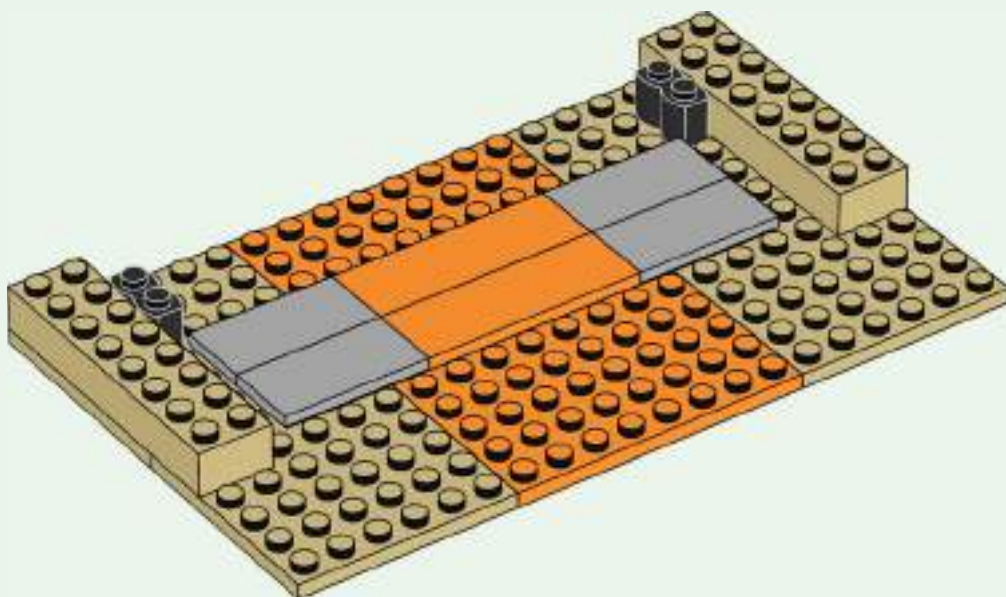



10

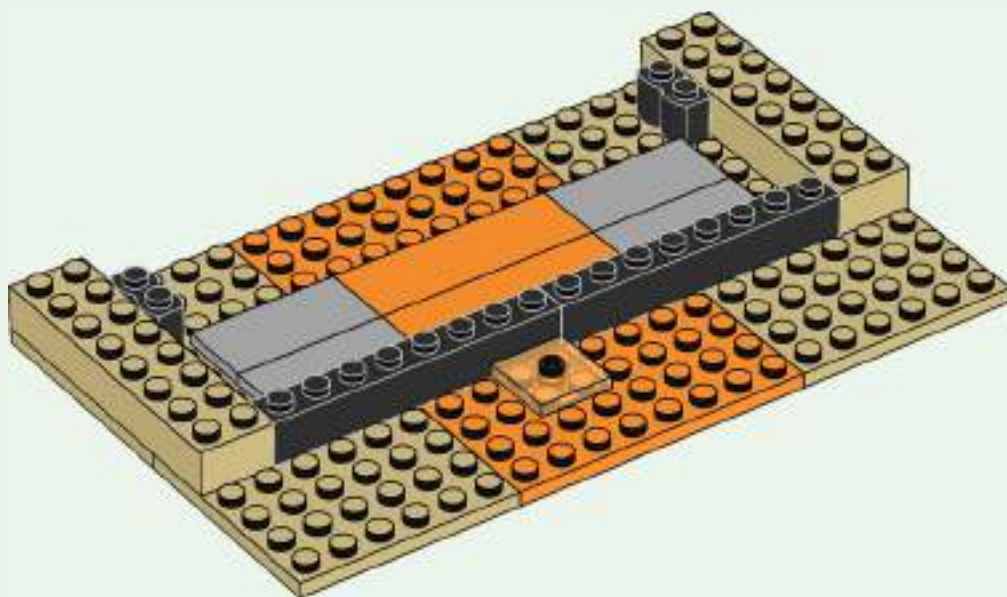



11

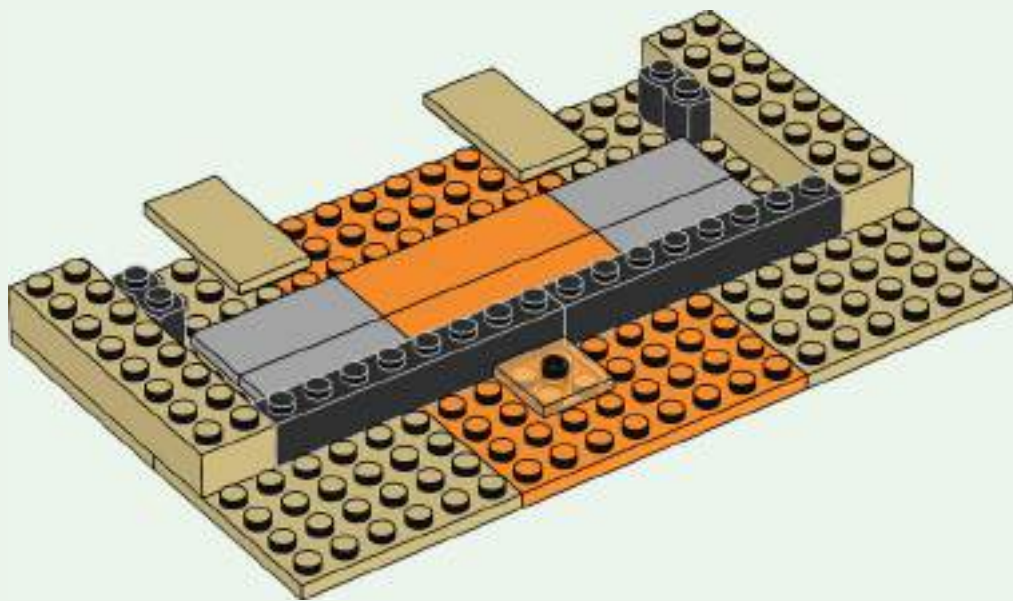

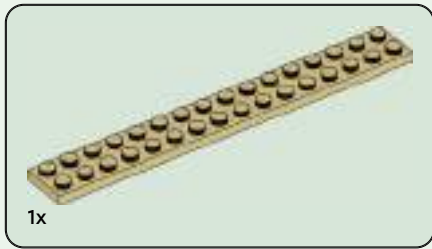

12

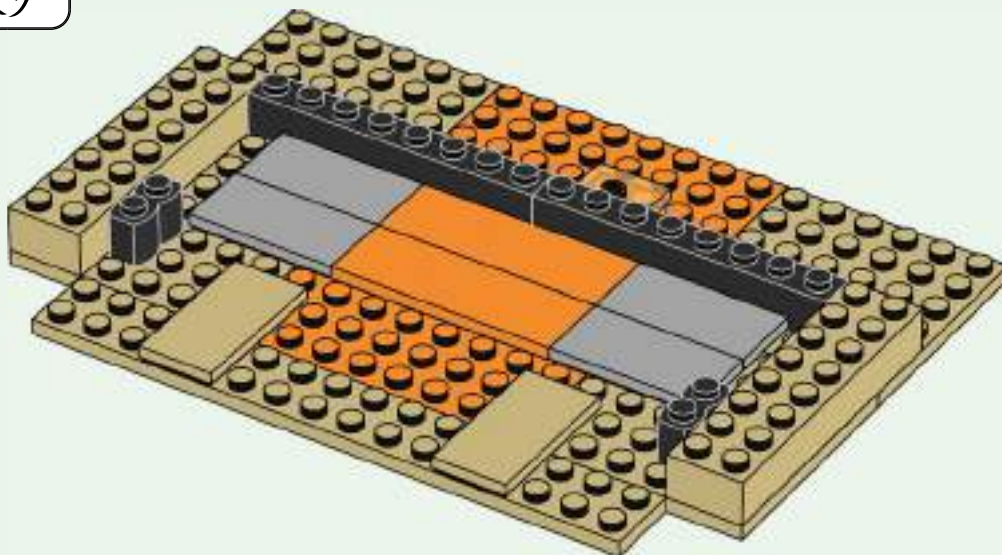



13

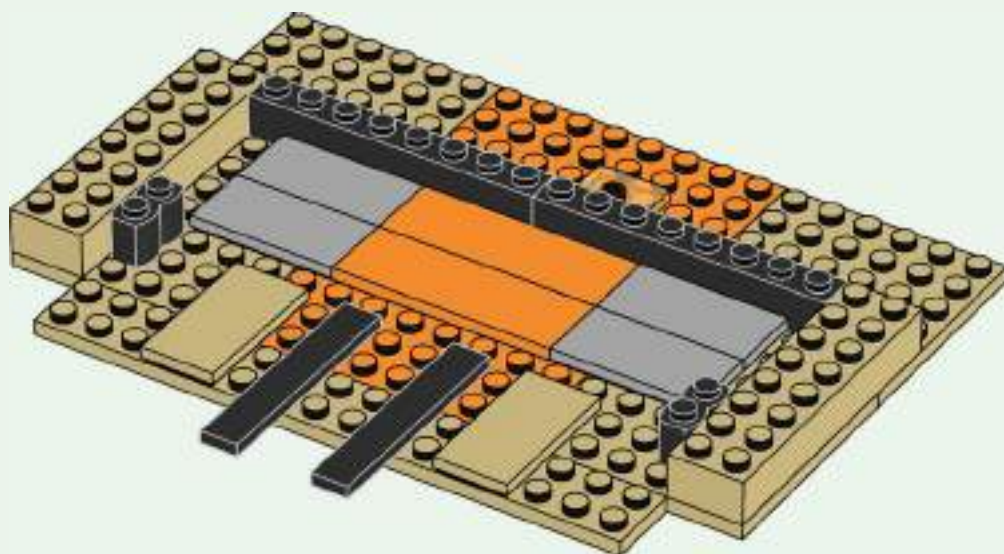



2x

15

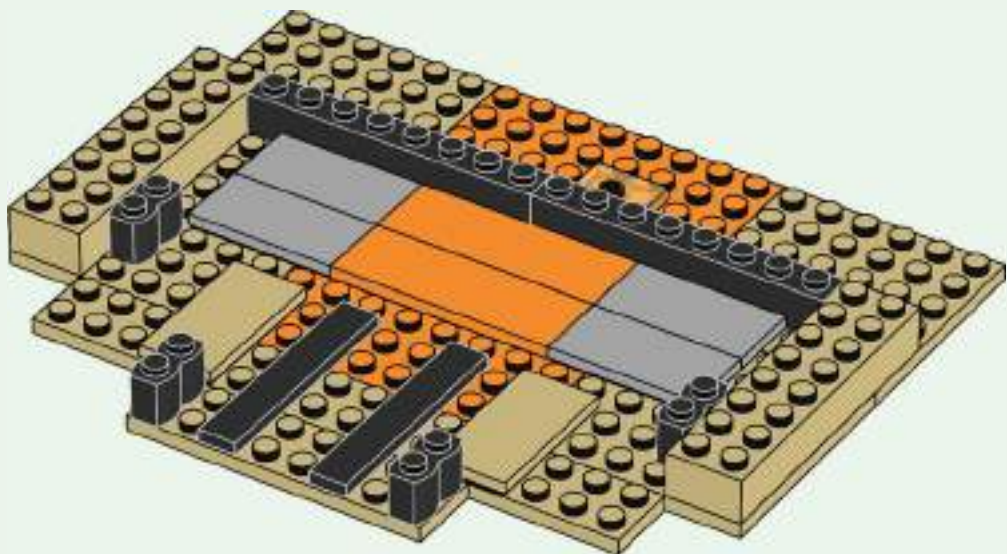



2x

16

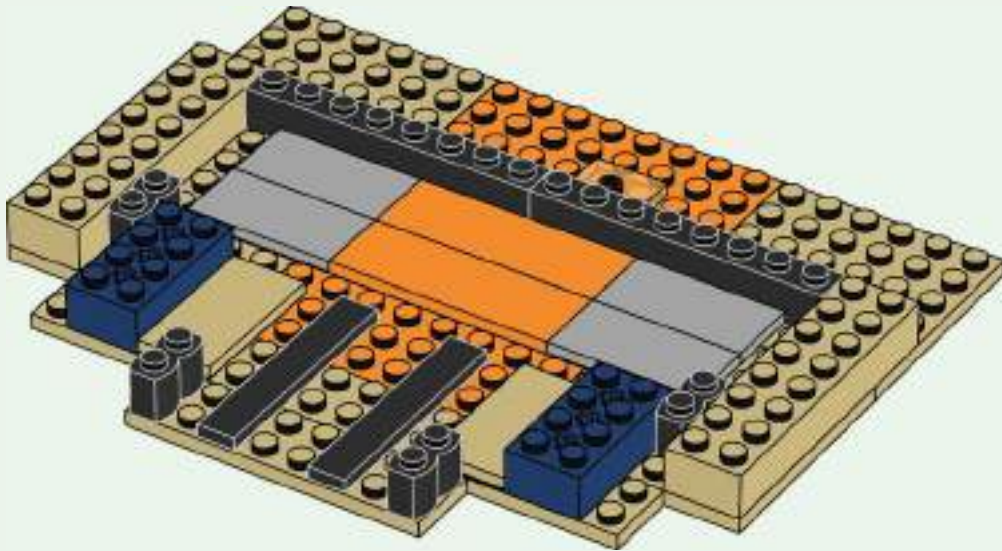



1x

17

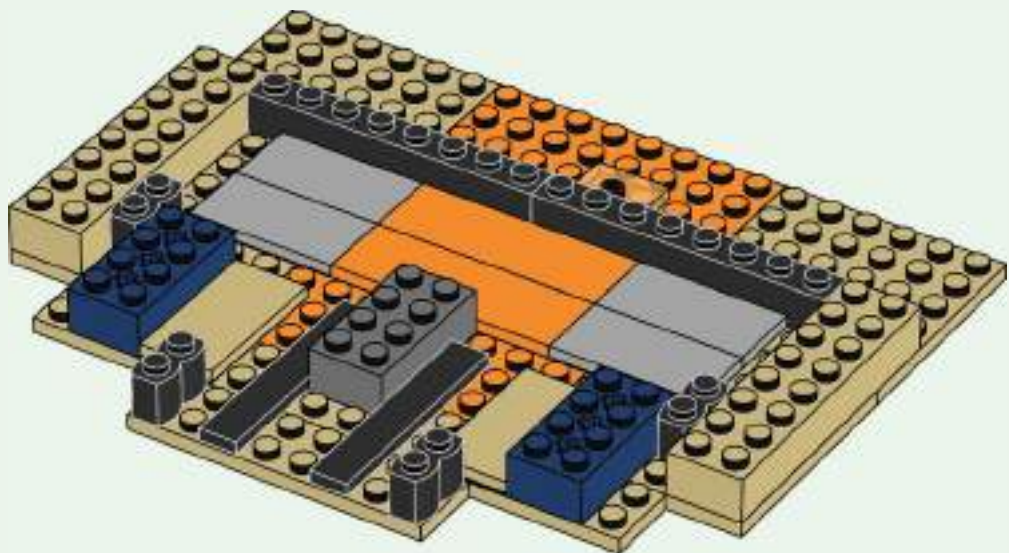



2x

18

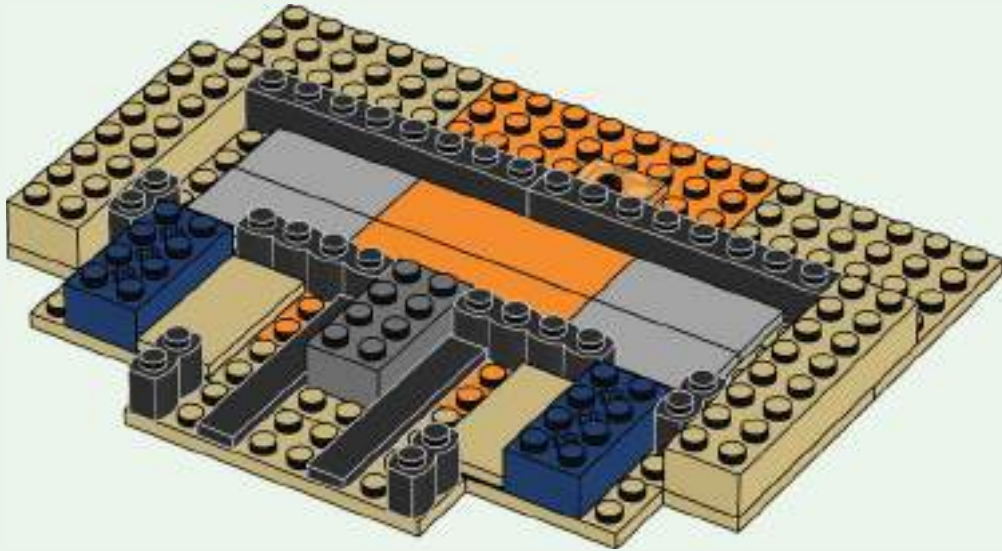



1x

19

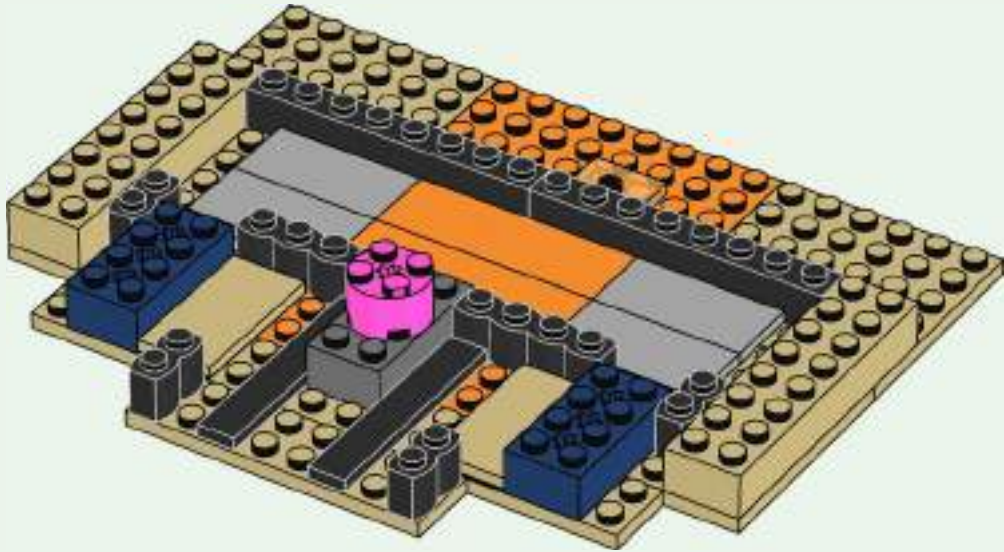

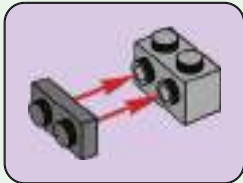
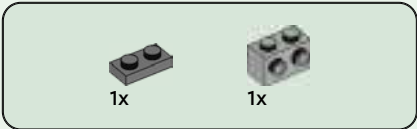

20

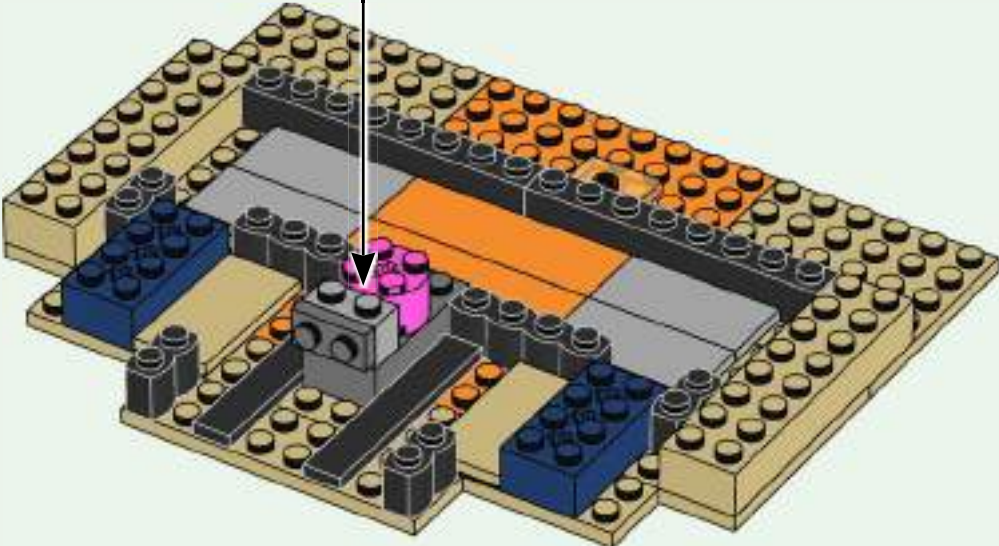



21

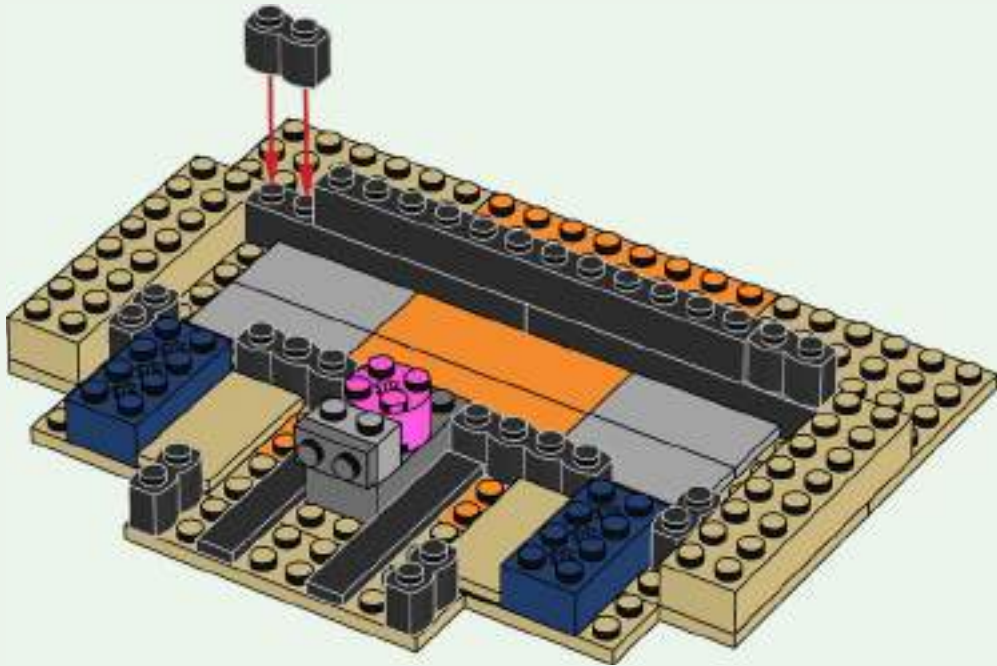



22

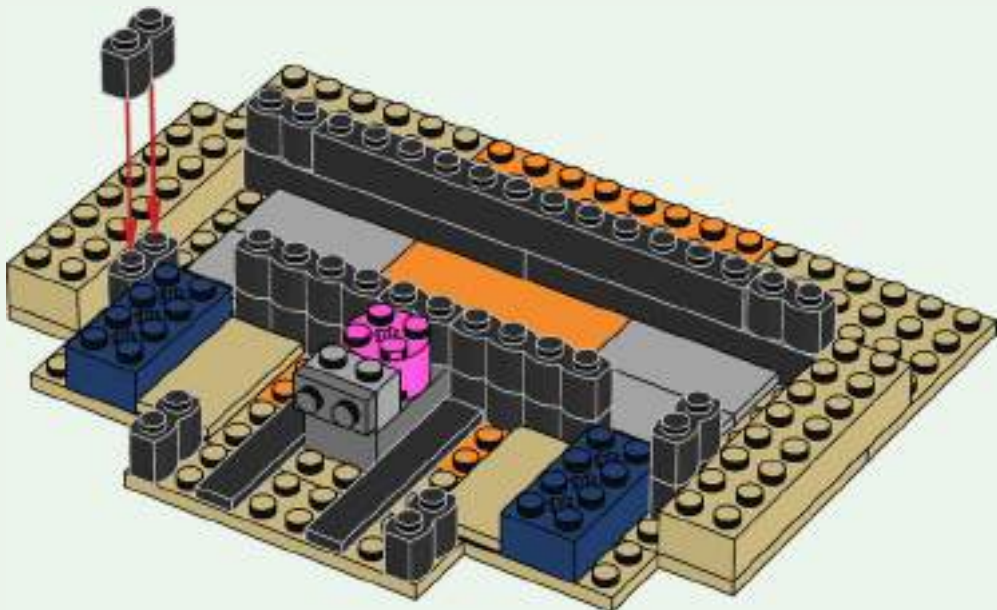

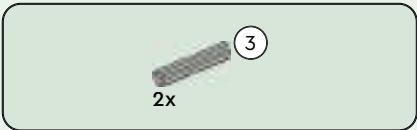

23

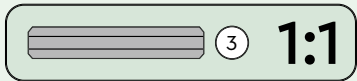
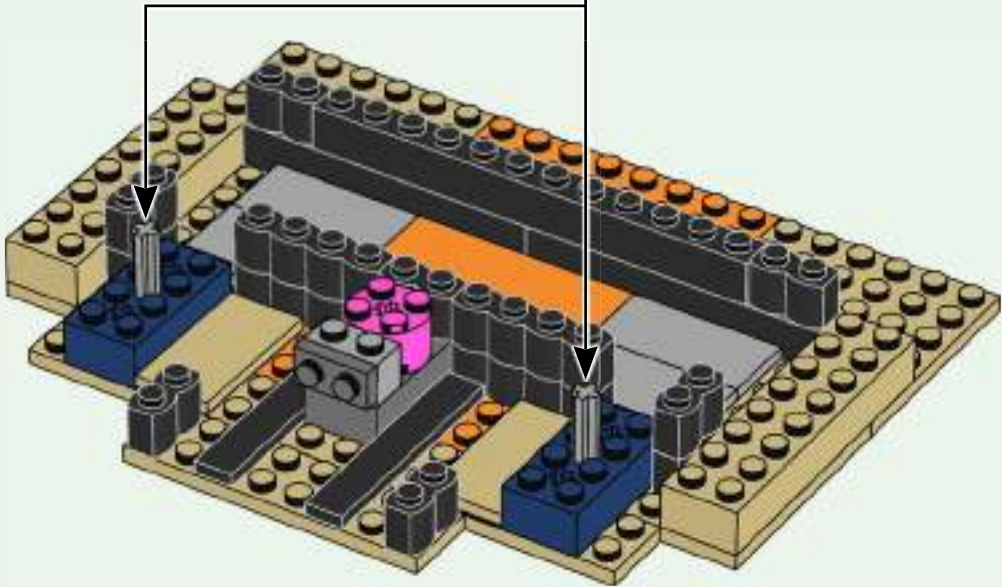

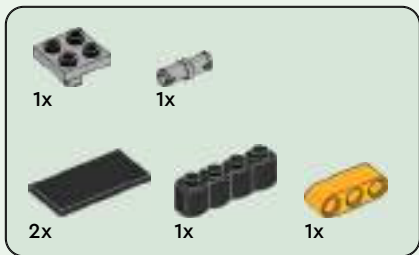

24

1



2



3



4

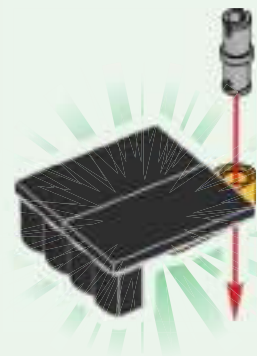

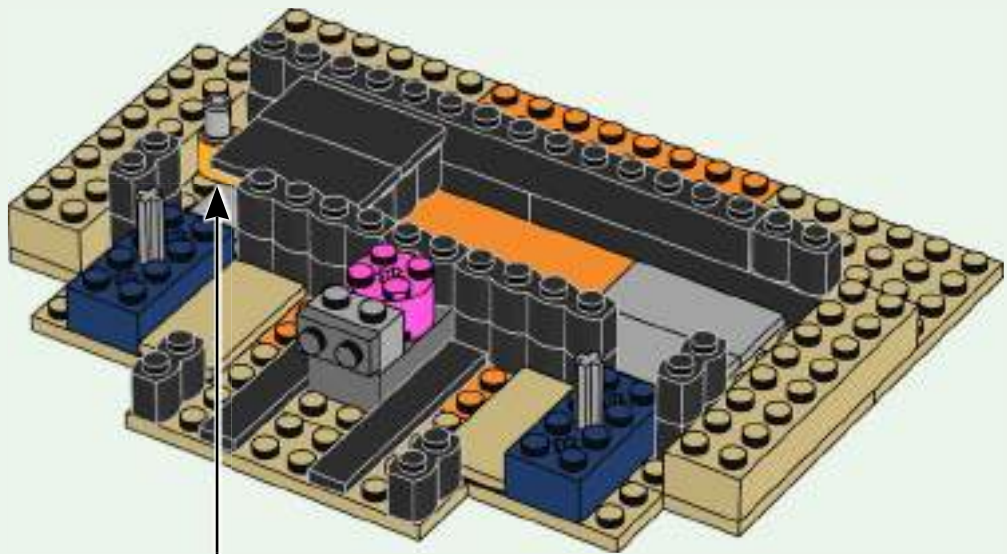

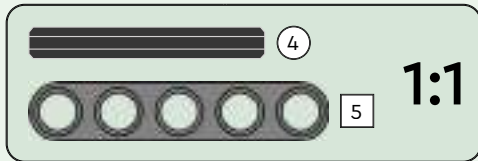
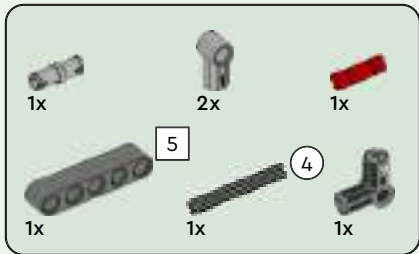

25

1



2



3

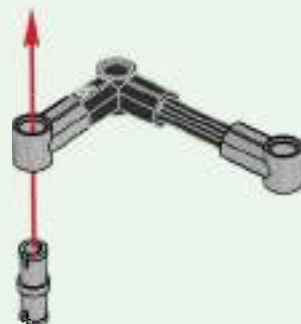

4

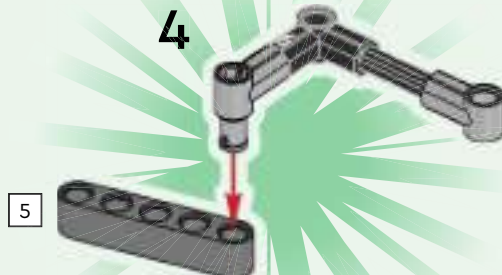

5



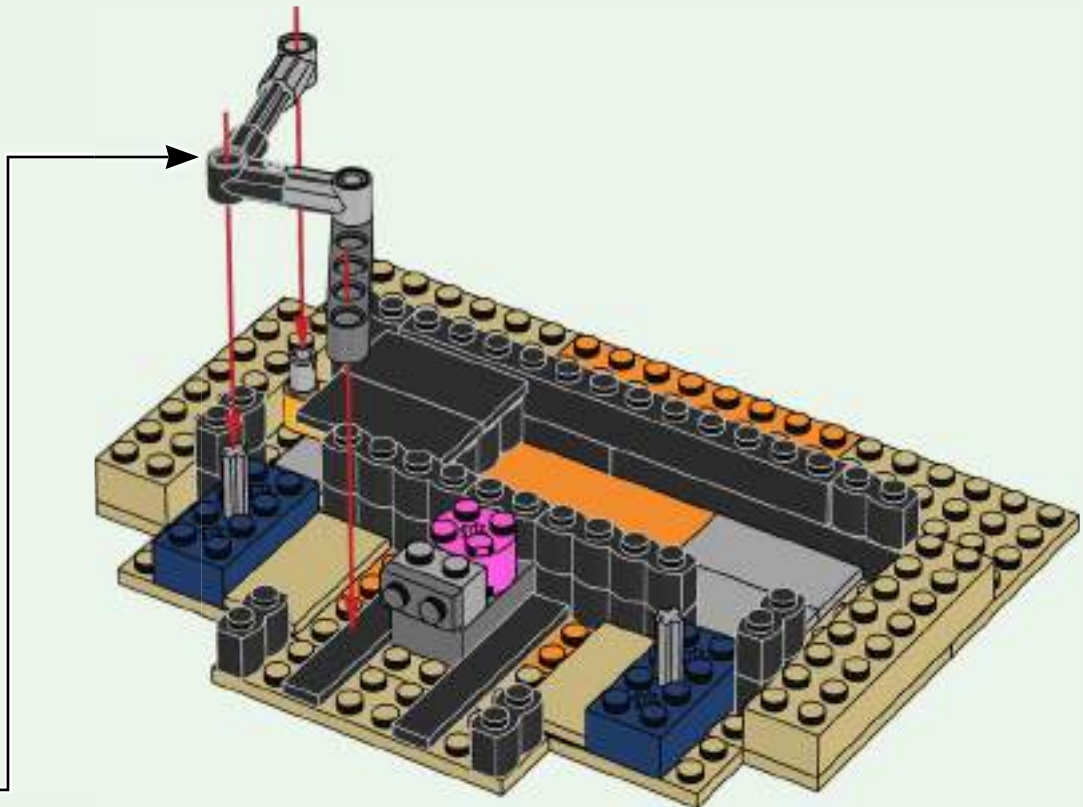



1x

26

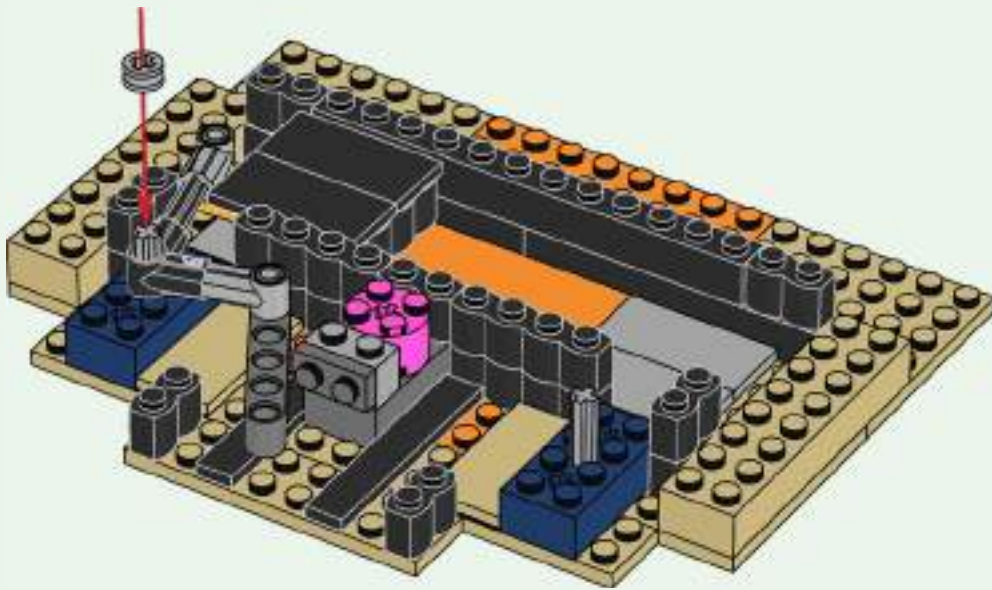

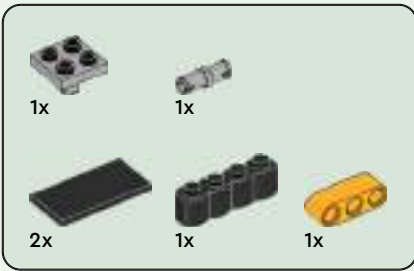

27

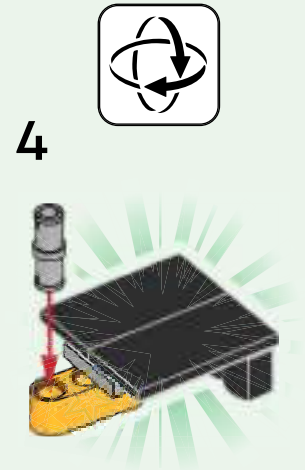
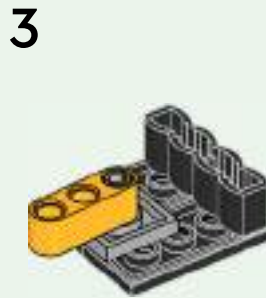
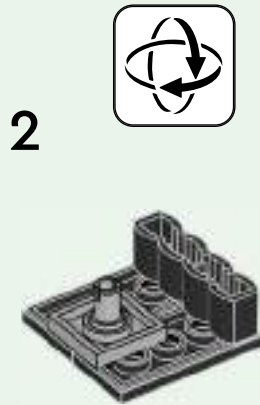
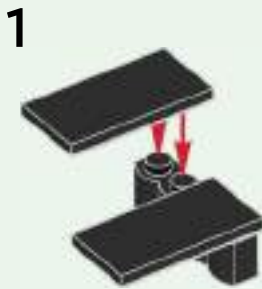

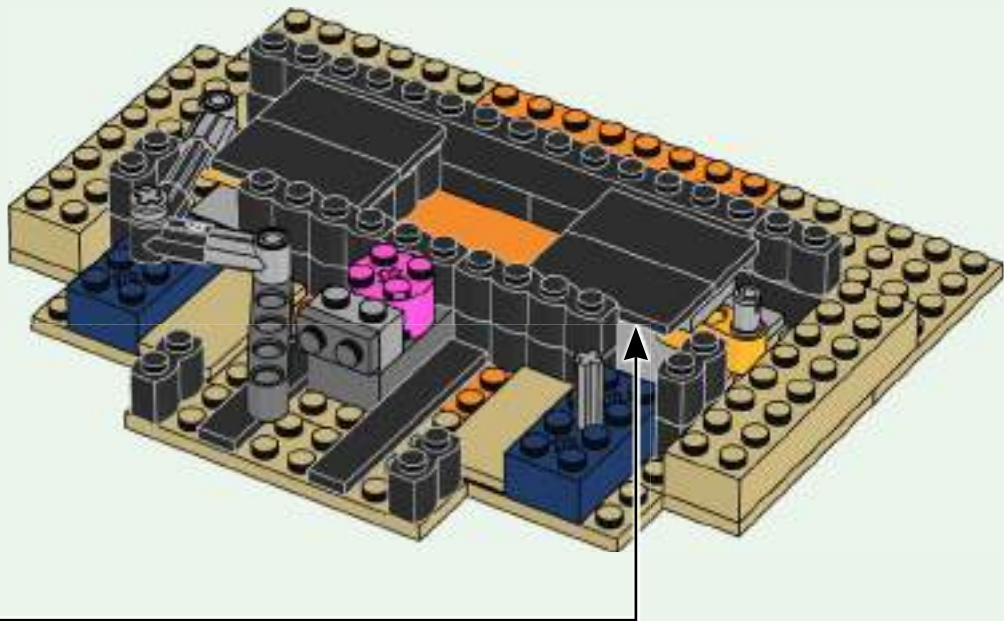

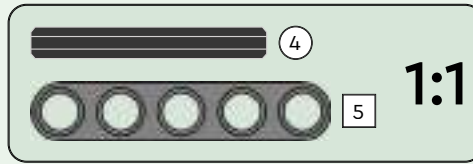
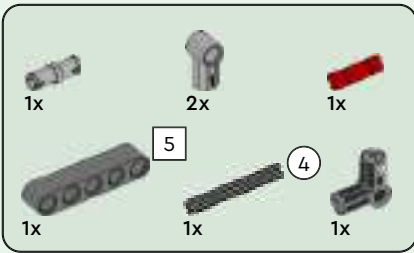

28

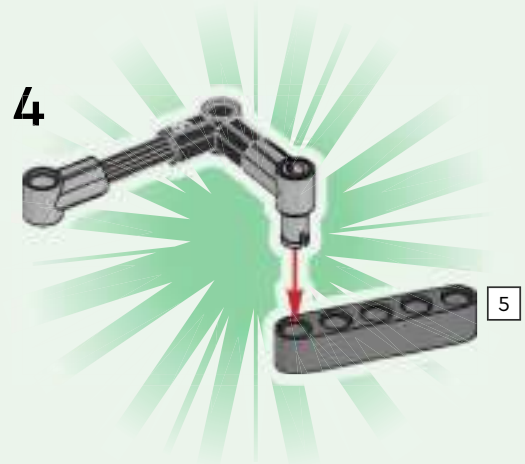
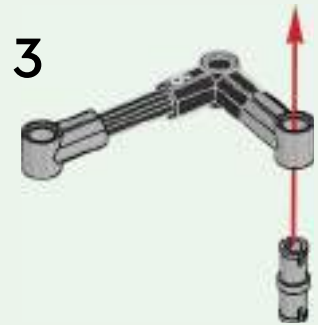

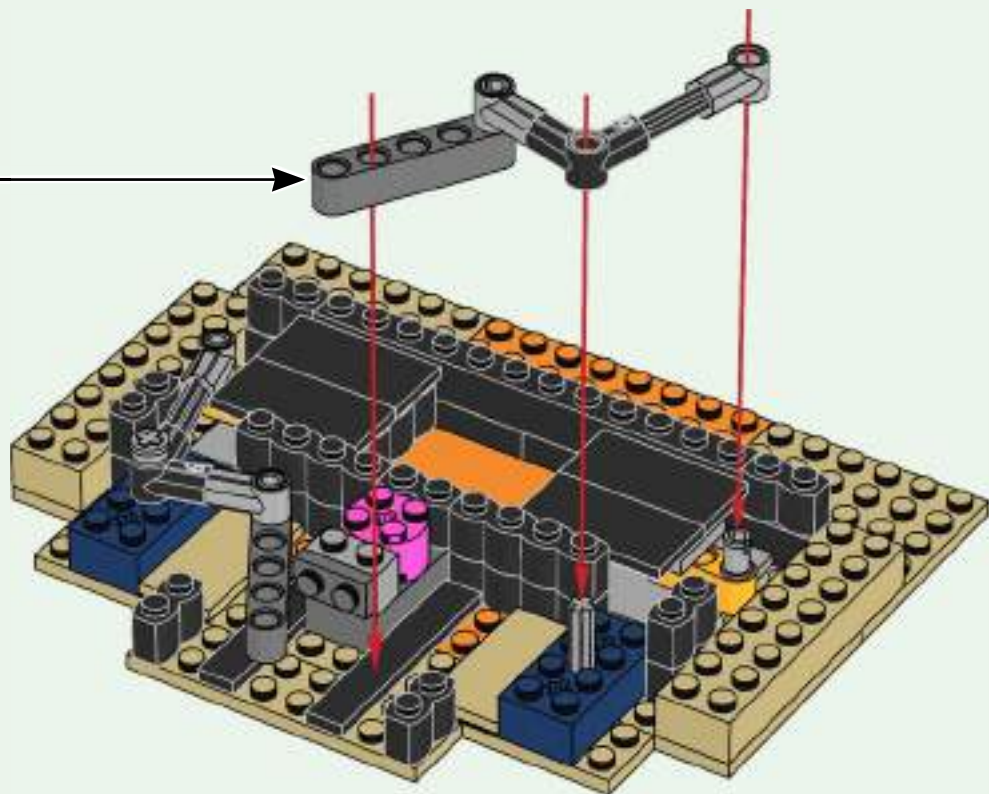



1x

29

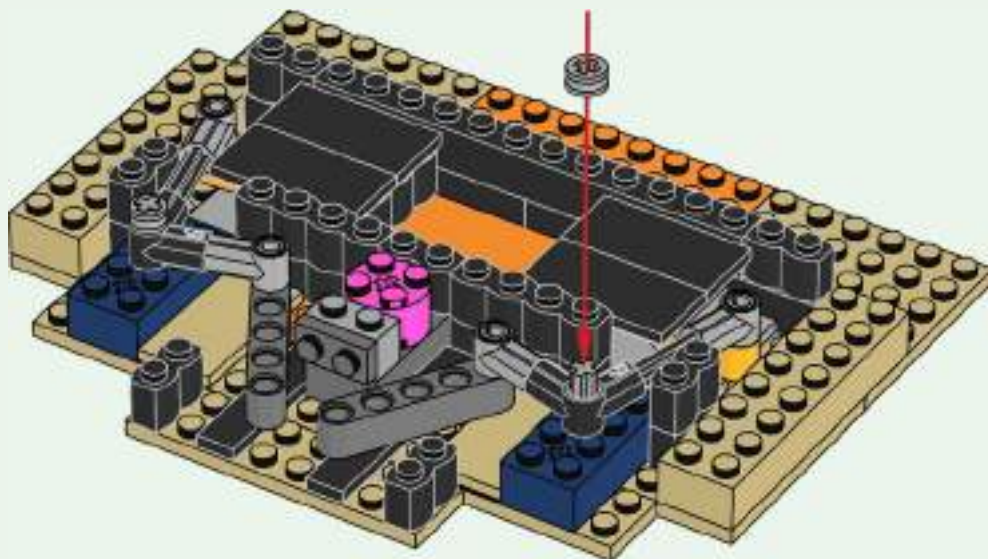



30

1

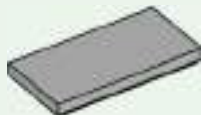

2

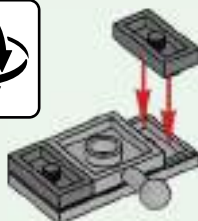

3

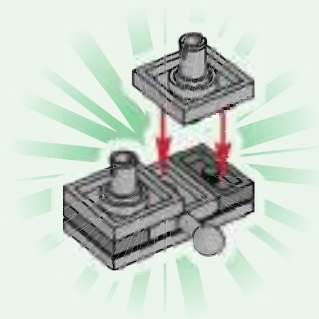

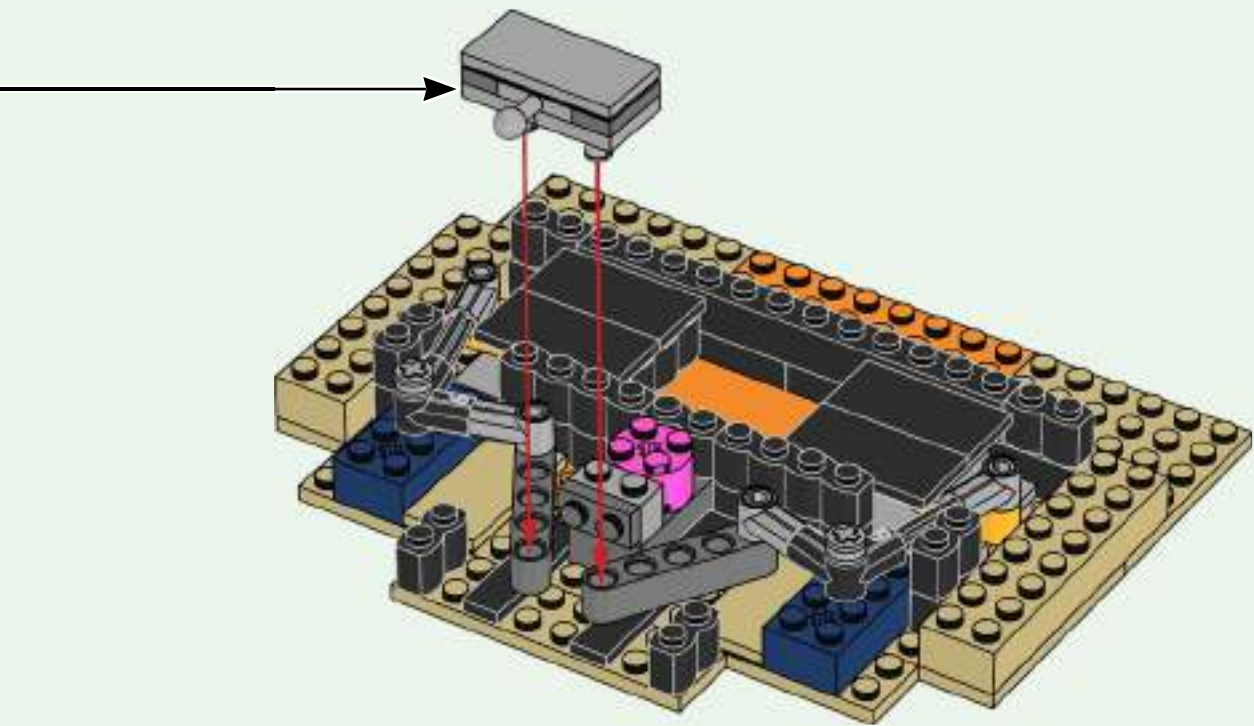



2x

31

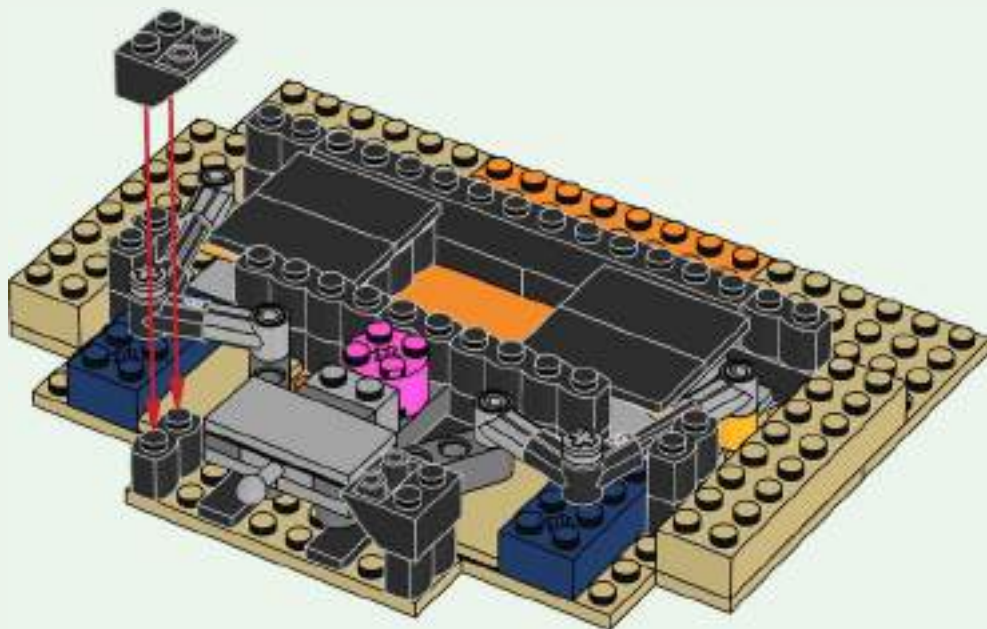

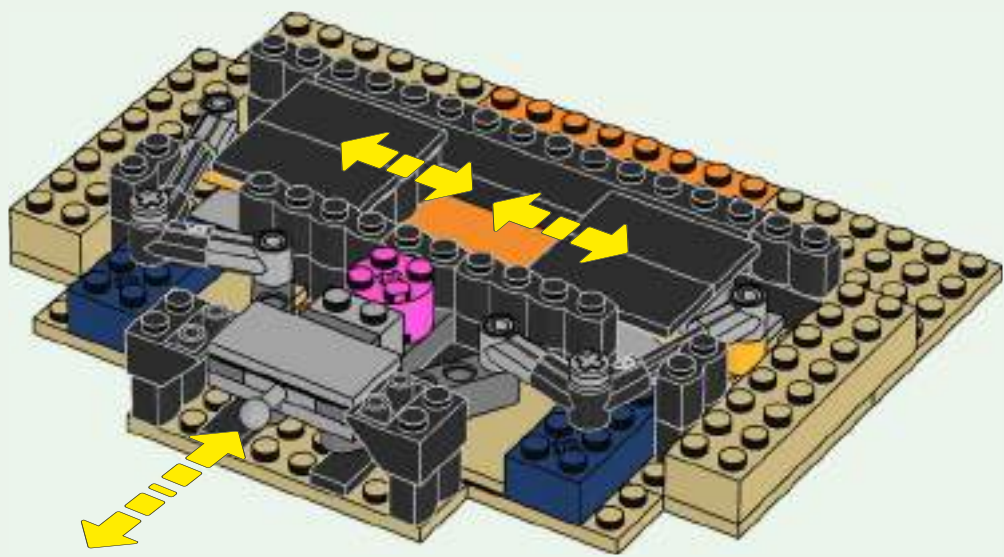



32

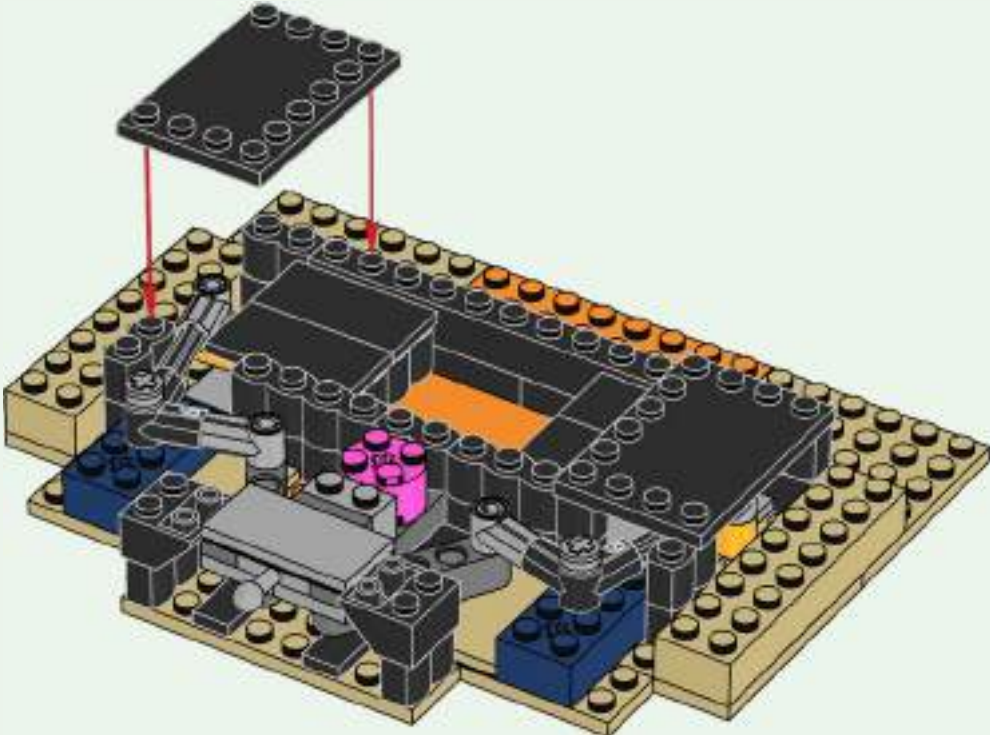

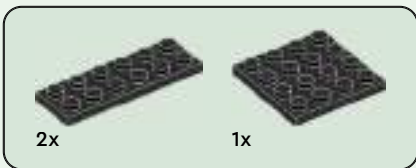

33

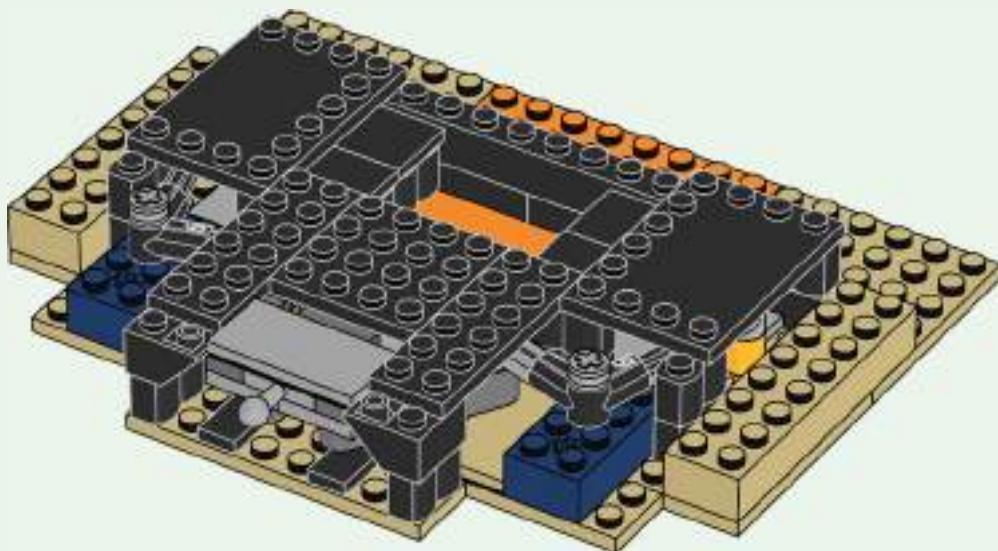



2x

34

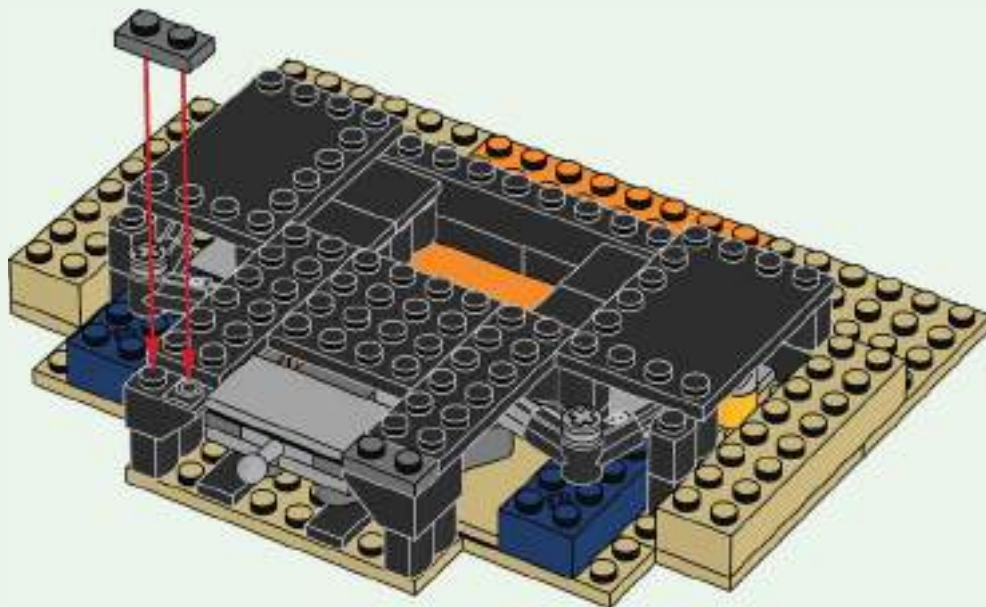



2x



2x

35





2x

36



2x

37





1x

38





39

1



2



3







40

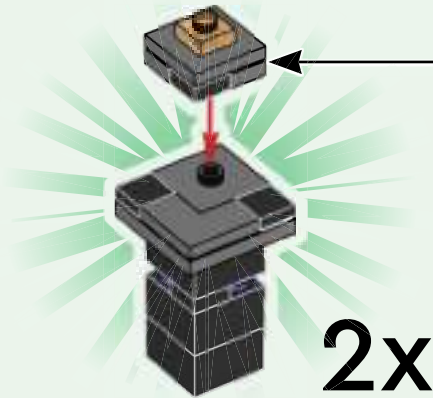
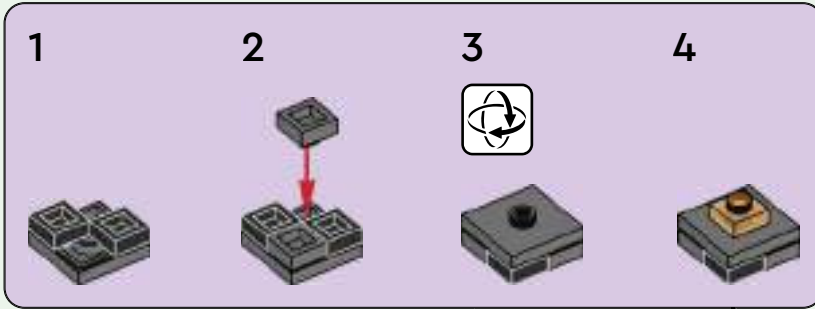

41

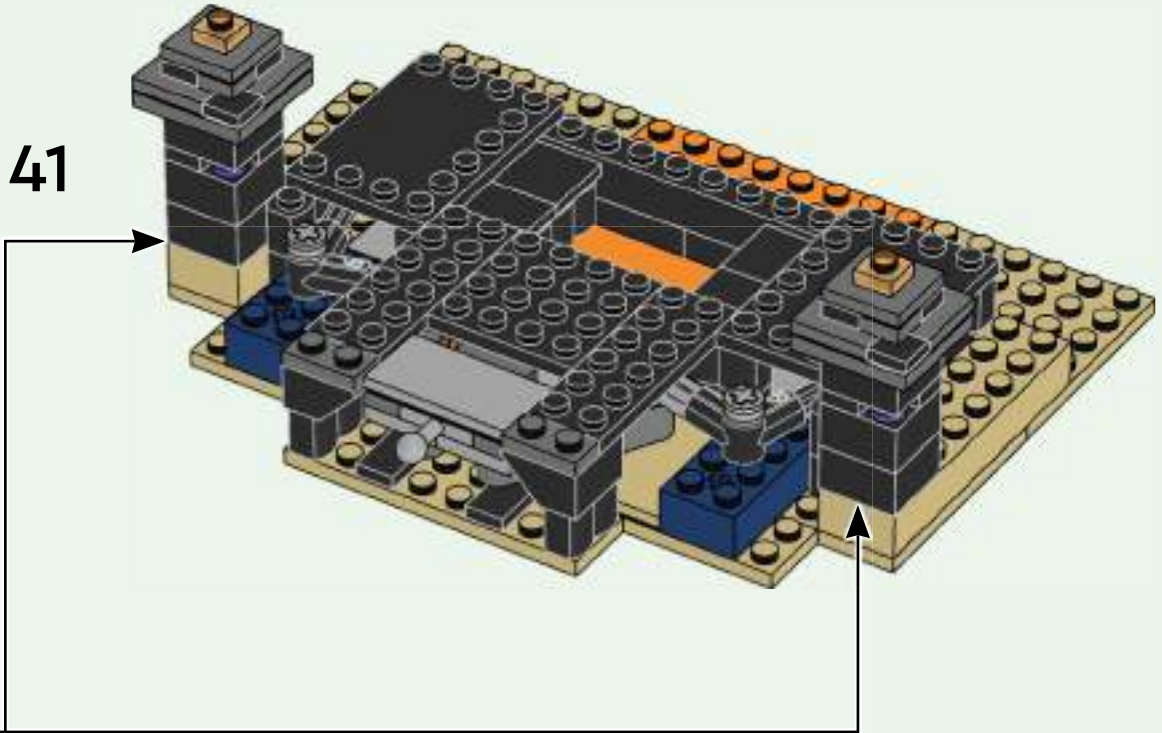



3



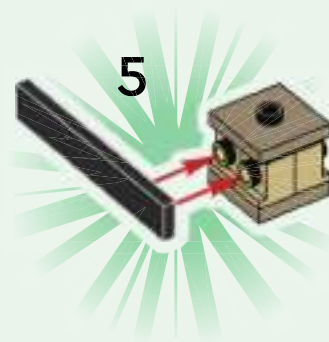
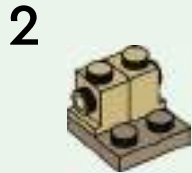
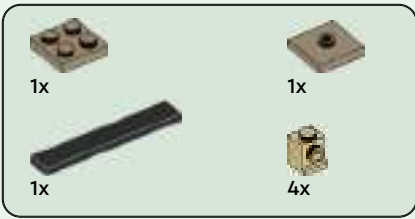

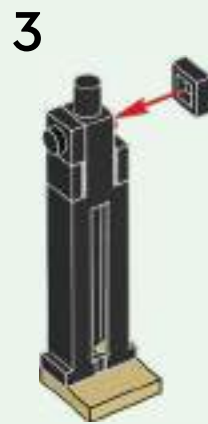
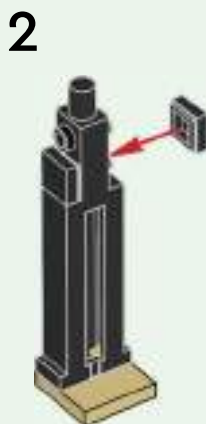
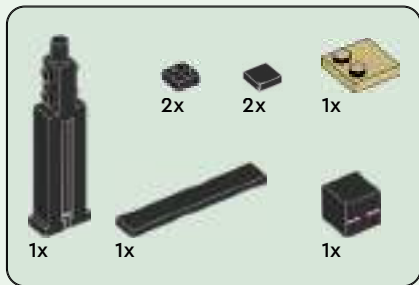

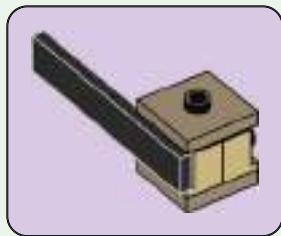

4

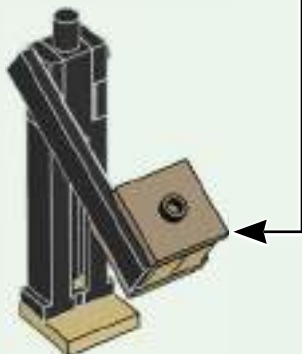

5



6



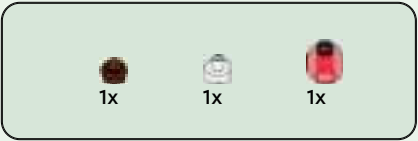

1



2



3



4



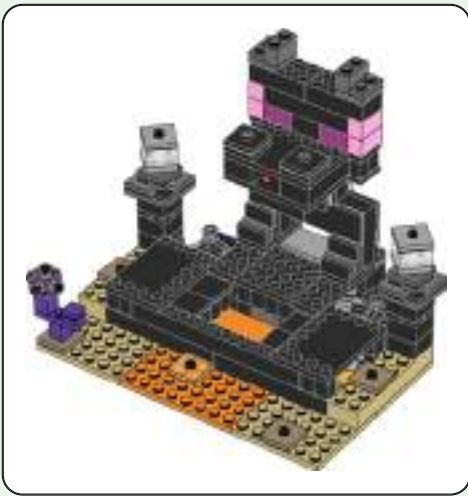

2x



2x



2x



2x

42

1



2



3



2x



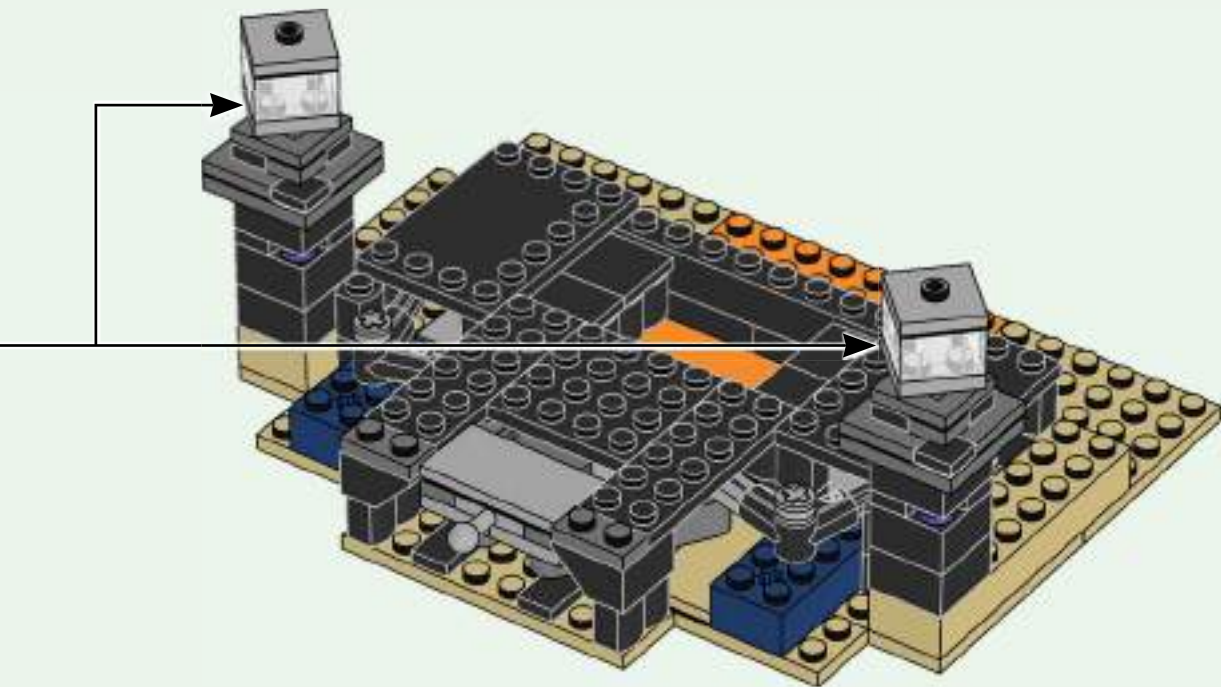



43

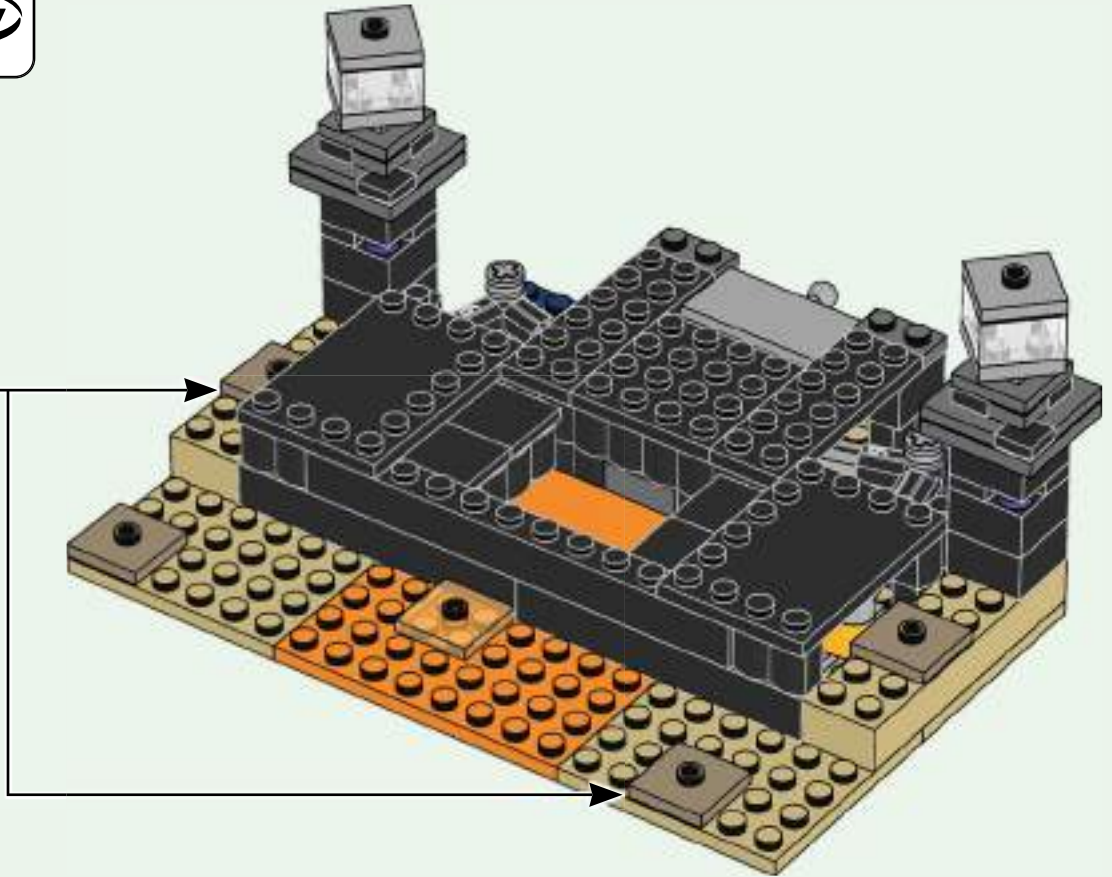

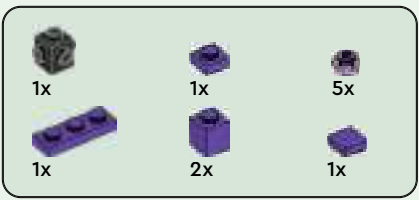

44

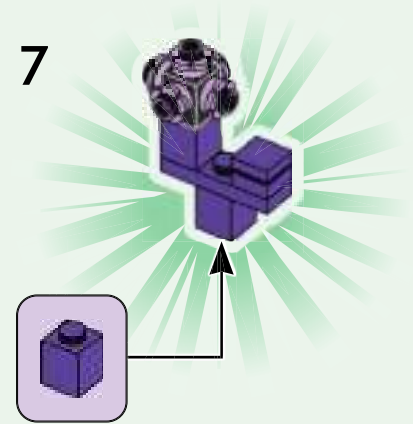
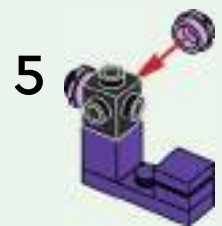
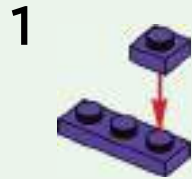

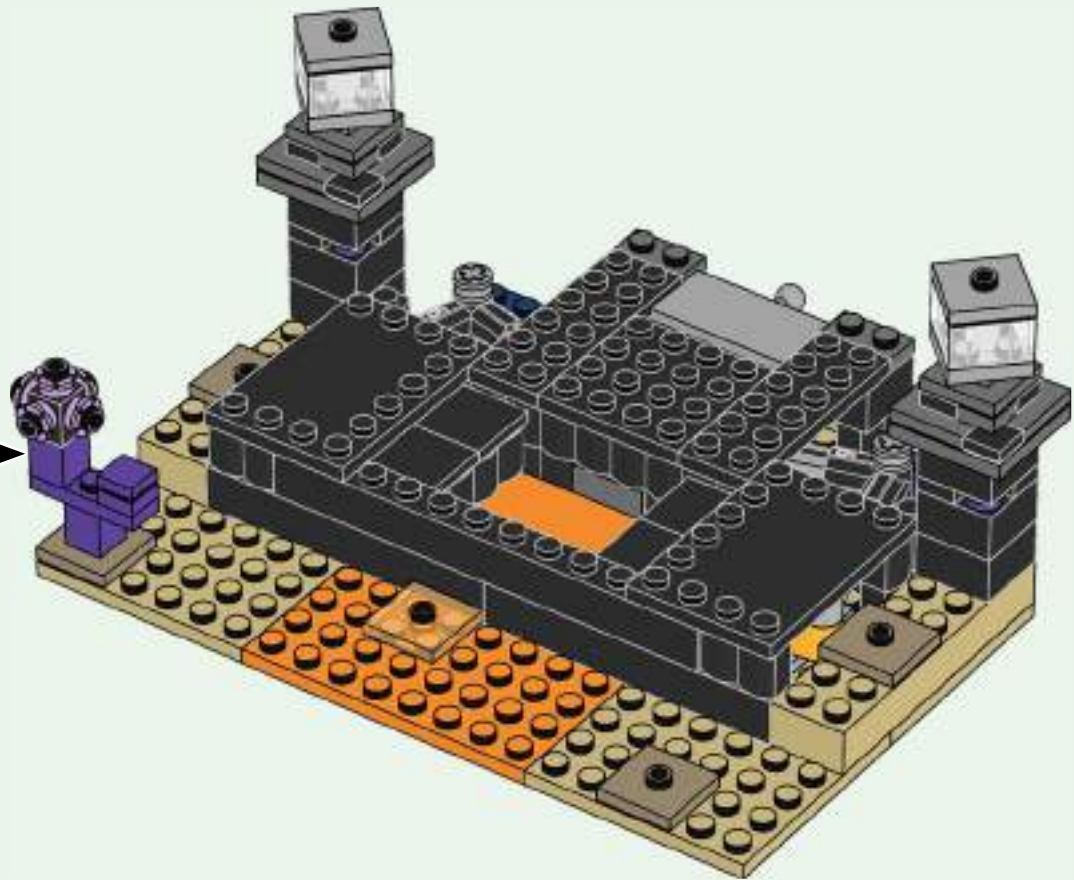

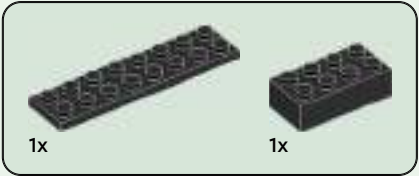
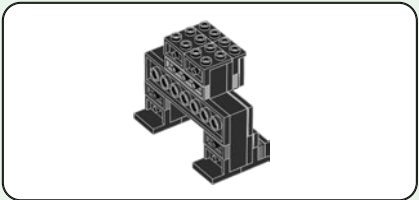

45

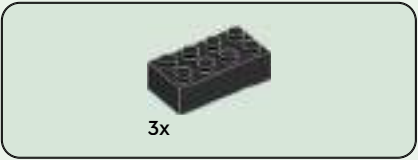

46



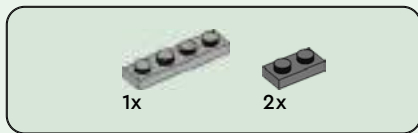

47

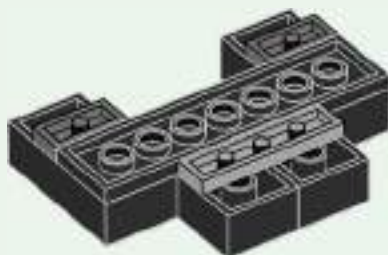

48

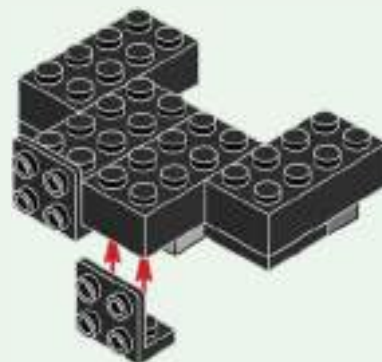

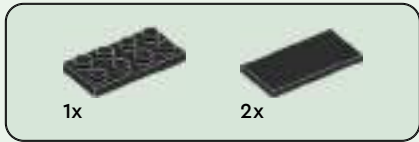

49

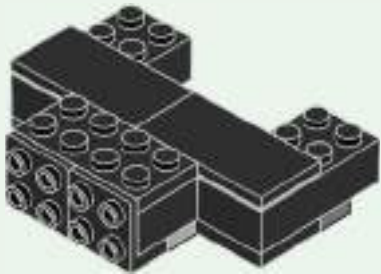

50

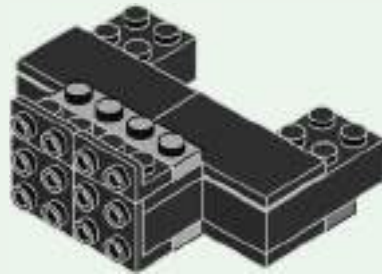



51

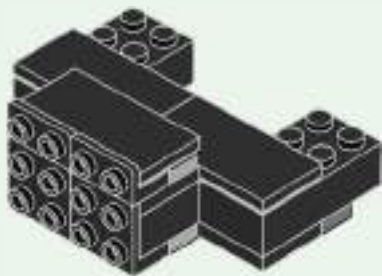

52

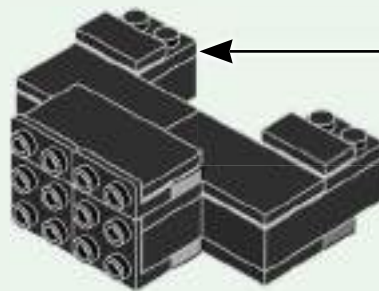
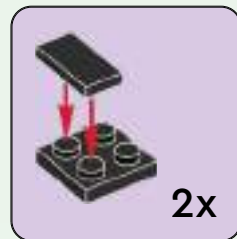

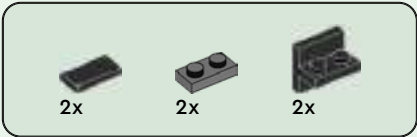

53

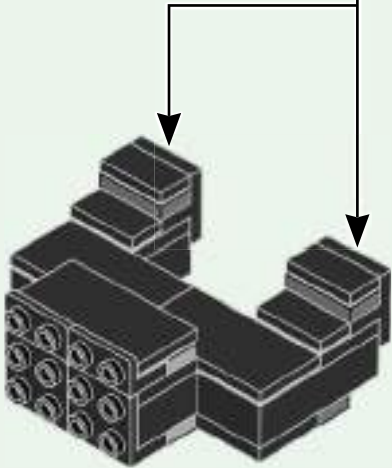
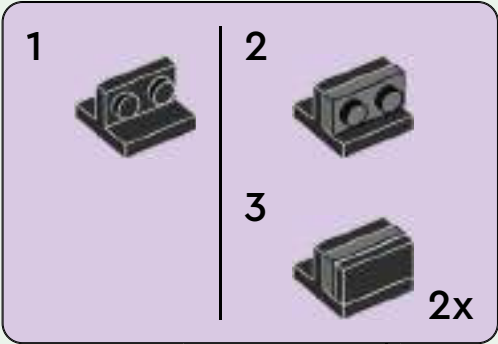

54

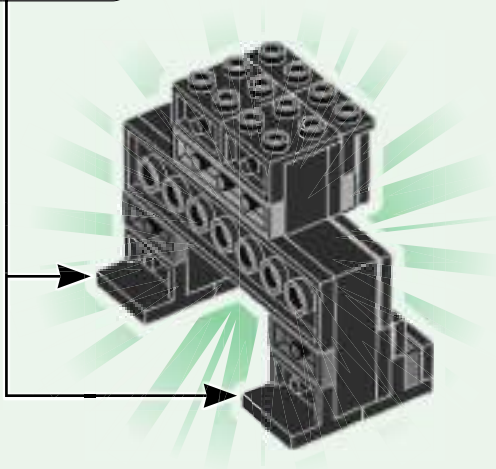

55

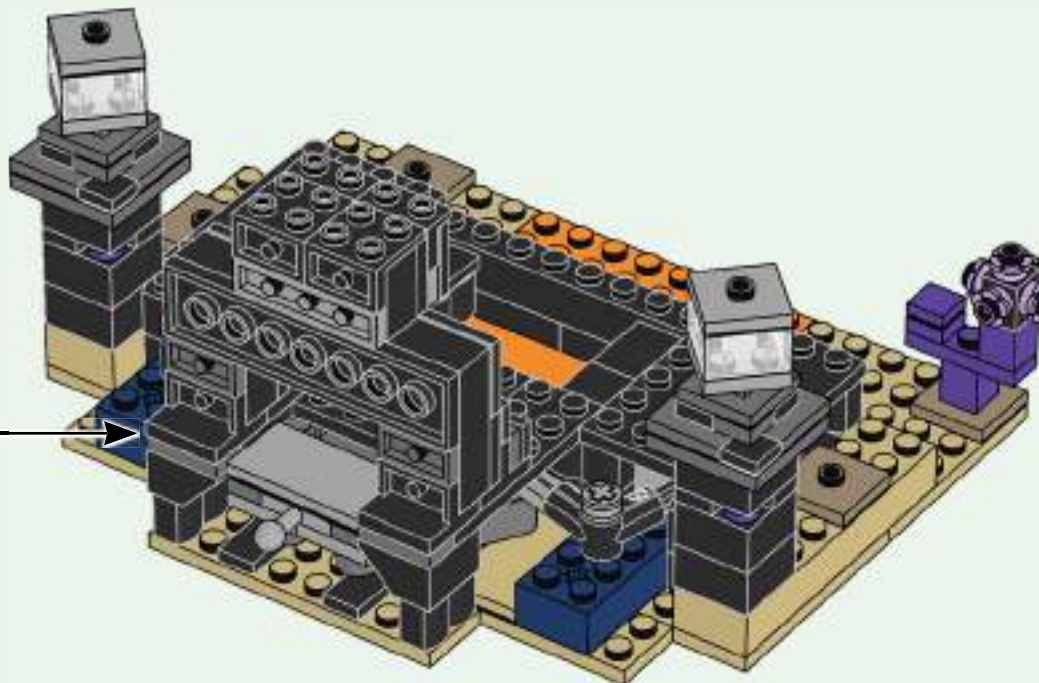



56



57

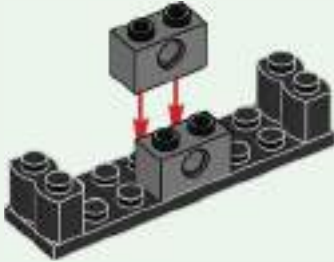

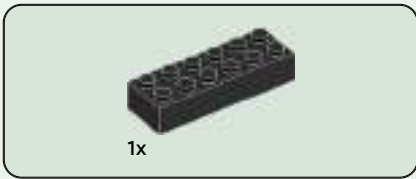

58



59

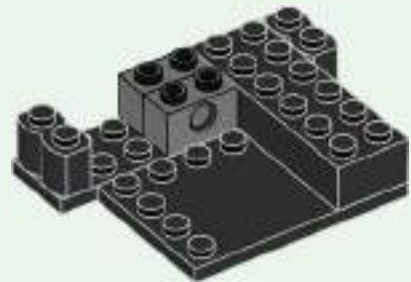

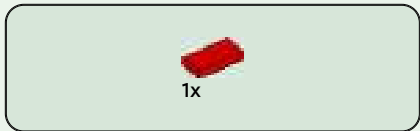

60

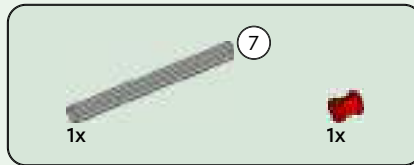

61

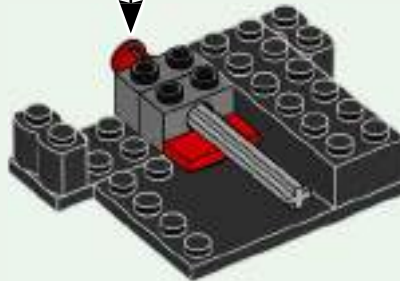
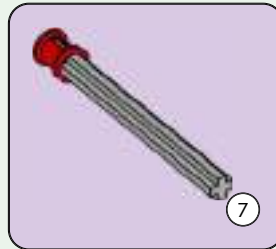



1x

62

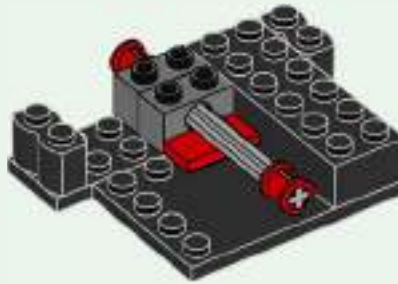



63

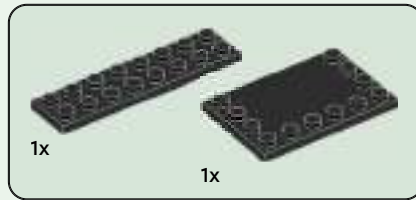

64

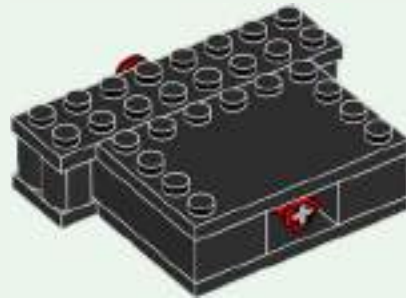

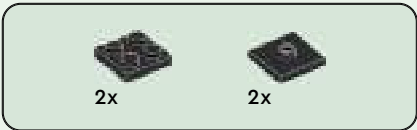

65

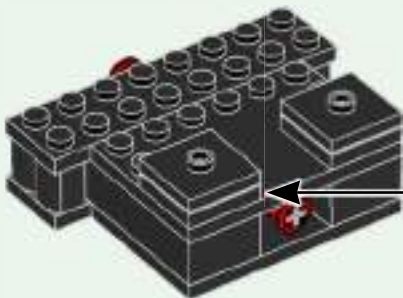

66

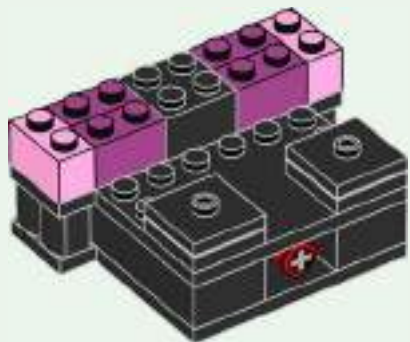

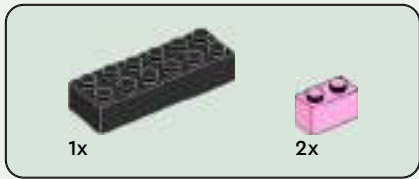

67

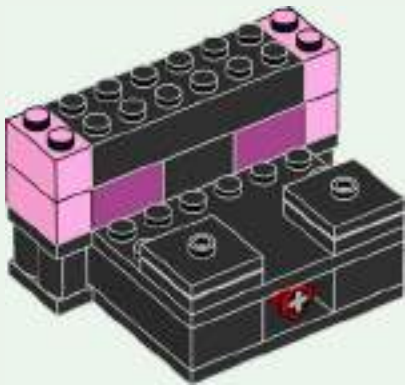

68

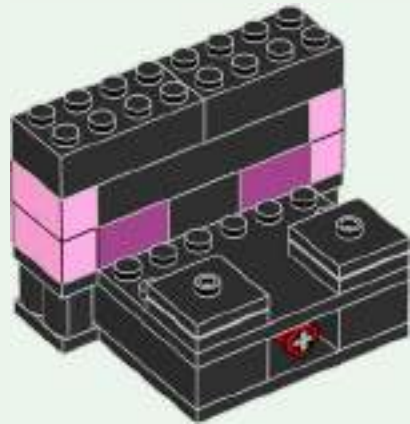



2x

69



2x



2x

70

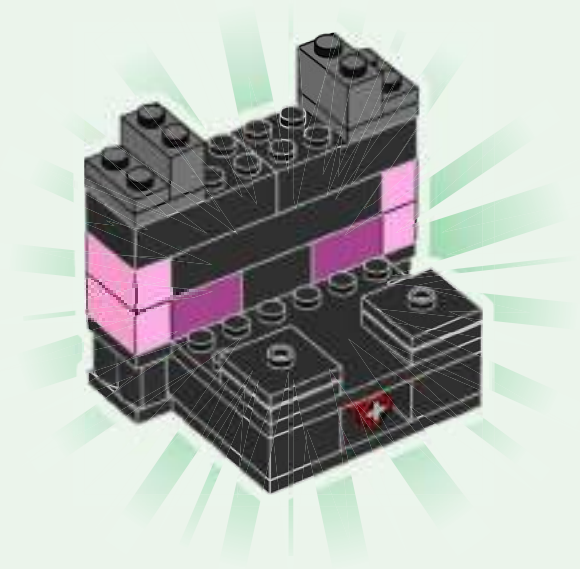

71

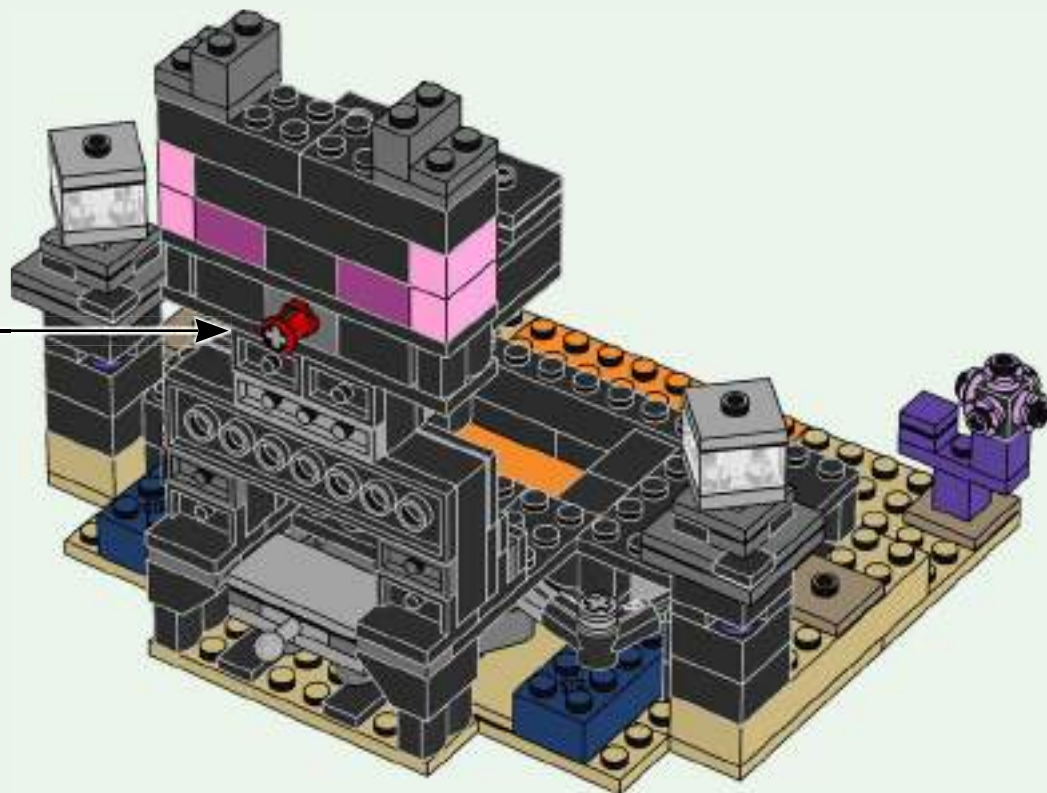

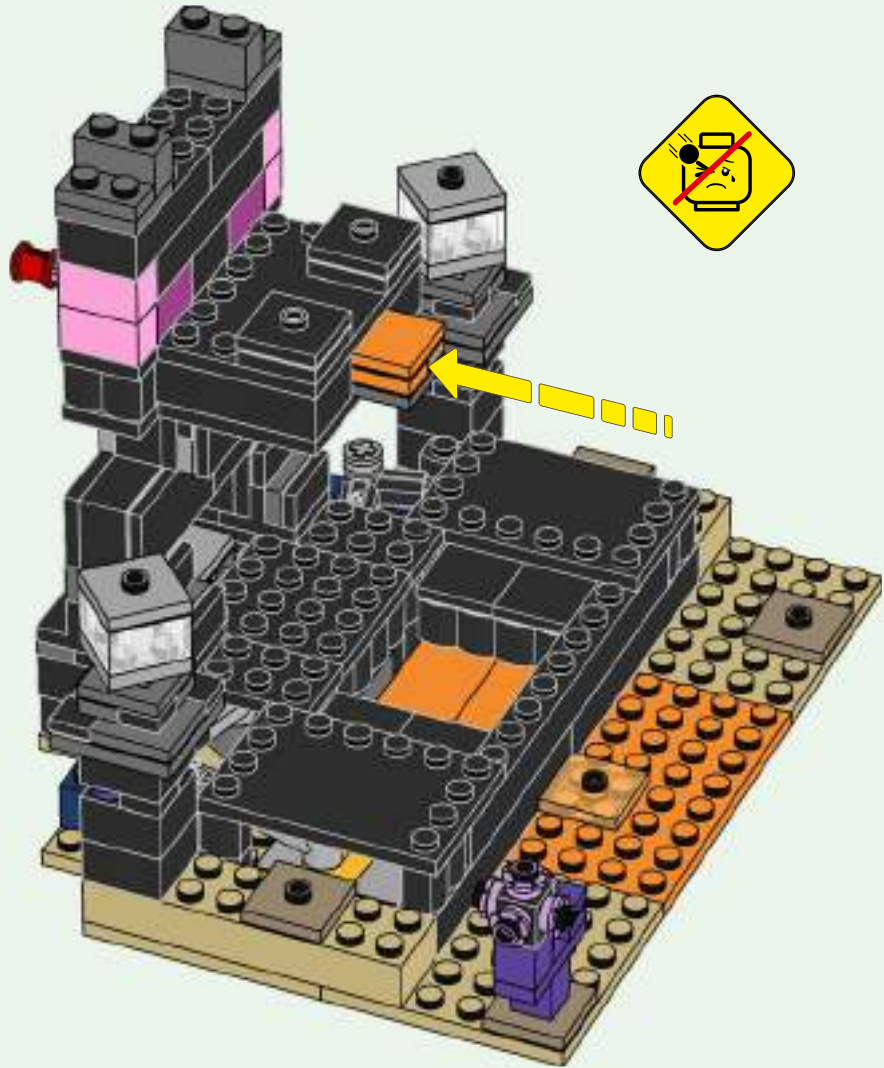

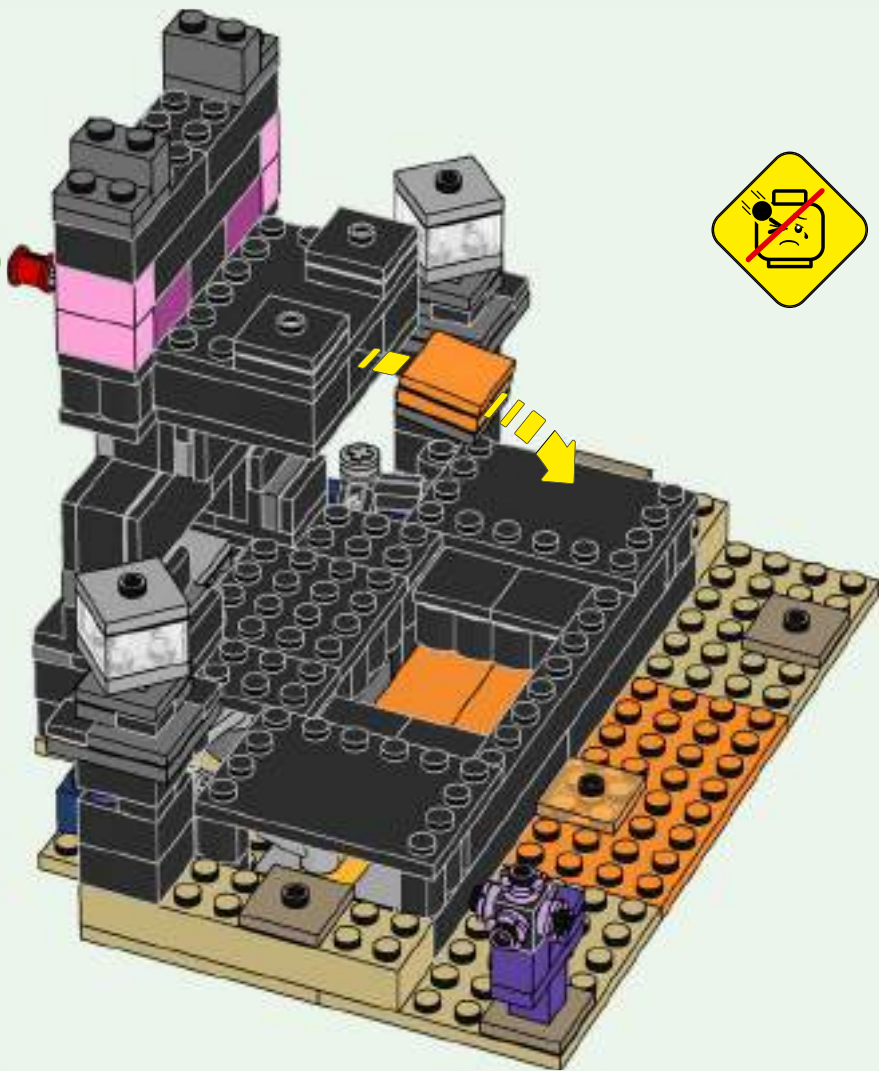
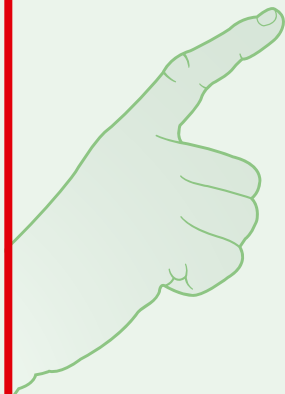





MINECRAFT

21243



21244



21241



21245





MINECRAFT

21242



21246



1x
4125253
1x
6422994
4x
4118793
1x
6221467
2x
6122047
1x
6030980
1x
4113988
2x
6037398
4x
4125217
2x
6271820
2x
4142865
1x
306921
1x
6423958

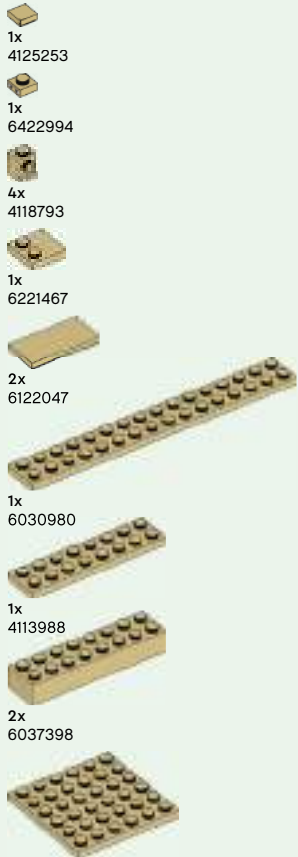

1x
6356406
10x
302426
6x
307026
1x
473326
11x
4644456
1x
6162466
2x
6268905
4x
306926
1x
6101874
2x
6020193
2x
6000650
4x
6250020
7x
300326



2x
6425507
4x
302226
2x
4565323
2x
370526
6x
6230228
7x
4560182
6x
300126
1x
302026
4x
663626
1x
4243819
3x
4181144
2x
379526



2x
300826
4x
4100378
3x
303426
1x
611226
1x
6186867
2x
6239418
1x
6276023
1x
4177932
1x
4542142
2x
6387565
2x
6424454
4x
4519195

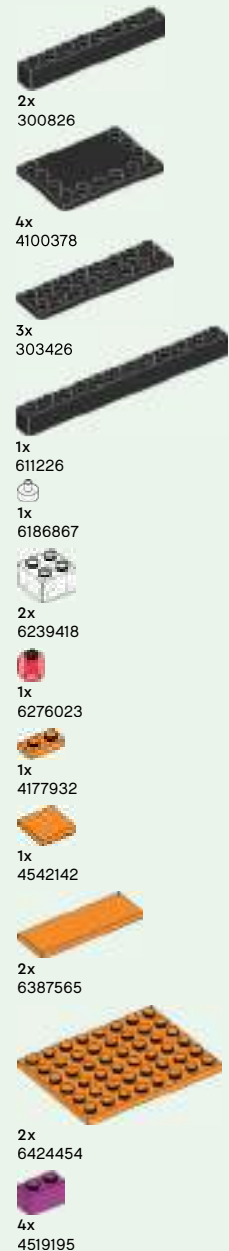



5x
6126075



1x
6047415



2x
6384912



1x
6411849



2x
6252040



1x
6240217



1x
6394956



2x
6418455



1x
4216581



1x
6078605



2x
6271165



4x
6296859



4x
4211807



1x
6015344



4x
6276848



2x
4211397



2x
6126082



2x
4211815



1x
6359225



1x
6430844



2x
4211445



5x
4560183



1x
4211805



4x
4210719



11x
4211063



2x
4211088



2x
4211111



1x
6013082



2x
4211094



4x
6126083



2x
6247784



2x
6039176



1x
4211085



2x
4210686



1x
6422439



4x
4517993



4x
4566522



2x
6084028



1x
6231376



1x
6167457



1x
4586410



1x
6035470



1x
6424453



1x
6192830



1x
6167567



1x
6421063



1x
6426335



1x
6421062



1x
6430920



5x
6214235



1x
6186837



1x
6423956



1x
6262262



1x
6214216



1x
6350506

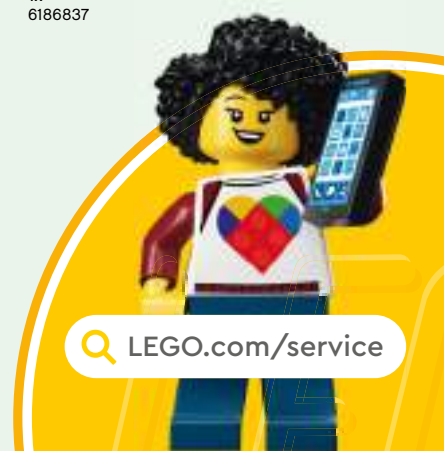

LEGO.com/service

YOU COULD **WIN**



Scan this QR code or go to **LEGO.COM/PRODUCTFEEDBACK** and give us your short feedback about this LEGO® set for a chance to win a cool LEGO prize.

Terms and Conditions apply*

DE: Du könntest GEWINNEN. Es gelten die Teilnahmebedingungen* **FR: Tu pourrais GAGNER.** Des conditions s'appliquent* **IT: Potresti VINCERE tu.** Termini e condizioni sono applicabili* **ES: Puedes GANAR.** Aplican términos y condiciones* **PT: Poderá GANHAR.** Aplicam-se termos e condições* **JA: プレゼント付き! 利用規約が適用されます*** **ZH: 轻松获奖. 条款和条件适用*** **KO: 상품의 주인이 되어보세요. 소정의 약관이 적용됩니다*** **RU: Вы можете ВЫИГРАТЬ.** Действуют положения и условия* **PL: Szansa na WYGRANĄ.** Obowiązują warunki korzystania* **CS: Máte šanci VYHRÁT.** Platí všeobecné smluvní podmínky* **SK: Máte šancu VYHRAŤ.** Platia všeobecné zmluvné podmienky* **HU: TE IS NYERHETSZ.** Felhasználási feltételek érvényesek* **RO: Ai putea CÂȘTIGA.** Se aplică termeni și condiții* **BG: Можете да СПЕЧЕЛИТЕ.** Има определени правила и условия* **LV: Tu vari LAIMĒT.** Ir spēkā noteikumi un nosacījumi.* **ET: Sul on võimalus VÕITA.** Kehtivad tingimused* **LT: Jūs galite LAIMĖTI.** Taikomos sąlygos*
*LEGO.com/productfeedback-terms

LEGO and the LEGO logo are trademarks of the LEGO Group. ©2023 The LEGO Group.



© 2023 Mojang AB. All Rights Reserved. Minecraft, the Minecraft logo, the Mojang Studios logo and the Creeper logo are trademarks of the Microsoft group of companies.

6448763