



Friends

41754





[LEGO.com/sustainable-packaging](https://LEGO.com/sustainable-packaging)

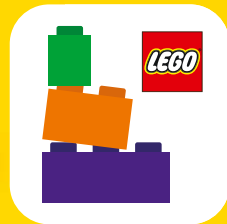

# BUILDER



Apple and the Apple logo are trademarks of Apple Inc., registered in the U.S. and other countries and regions. App Store is a service mark of Apple Inc. Google Play and the Google Play logo are trademarks of Google LLC. Tencent and the Tencent logo are trademarks of Tencent Inc.

Q [LEGO.com/devicecheck](https://www.lego.com/devicecheck)

**EN** Ask parents' permission before going online | **DE** Eltern um Erlaubnis bitten, bevor du online gehst | **FR** Demande l'autorisation d'un parent avant d'aller en ligne | **IT** Chiedi il permesso ai tuoi genitori prima di andare online | **ES** Pídeles permiso a tus papás antes de conectarte a Internet | **PT** Peça autorização aos pais antes de acederes online | **JA** オンラインになる前に ほご者の方のきょかをもらおう | **ZH** 上网前应先征得父母的同意 | **KO** 온라인 접속 전에 보호자 동의가 필요합니다 | **RU** Спроси разрешения у родителей, прежде чем заходить в интернет | **PL** Poproś rodziców o zgodę, zanim wejdiesz do Internetu | **CS** Než půjdeš na internet, požádej rodiče o svolení | **SK** Skôr než pôjdeš na internet, vypýtaj si povolenie od rodičov | **HU** Kérj szülői engedélyt, mielőtt online csatlakoznál! | **RO** Cere permisiunea părinților înainte de a te conecta online | **BG** Поискайте разрешението от родител, преди да влезете онлайн | **LV** Pirms došanās tiešsaistē palūdz atļauju vecākiem | **ET** Enne Interneti kasutamist küsi vanematelt luba | **LT** Prieš prisijungdami prie interneto, atsklaukite tėvų

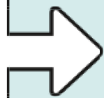
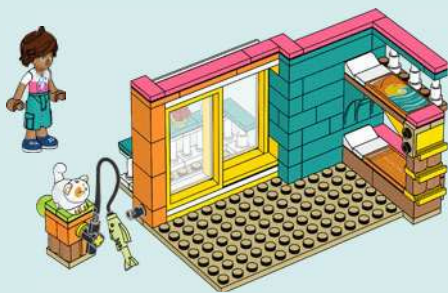

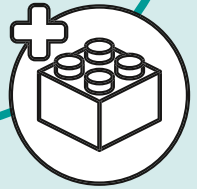
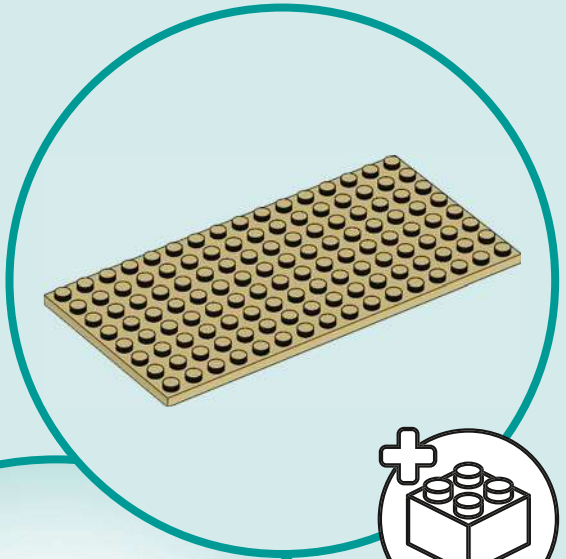

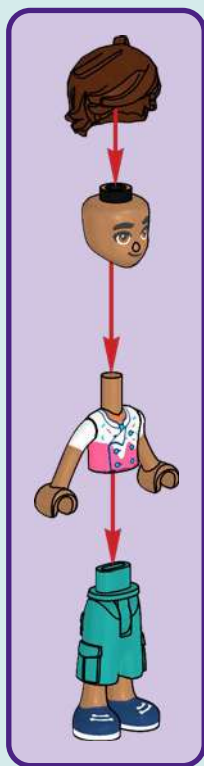

LEO





**OLLY**

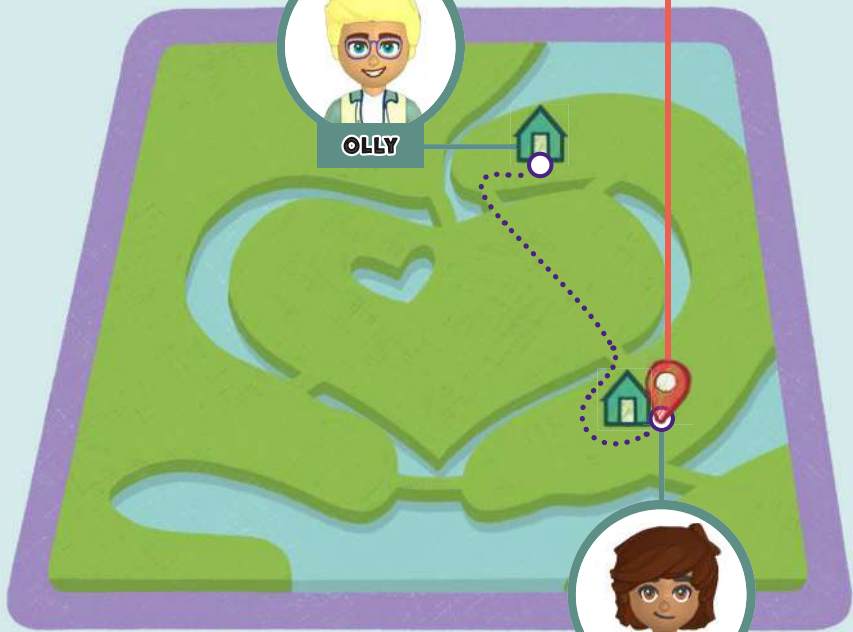

**LEO**







1x



1x

# 1

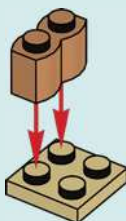

1x

# 2





2x

3





1x

4



2x

5



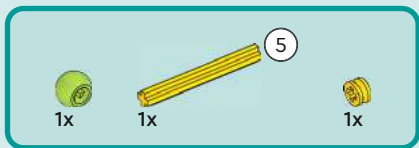

6

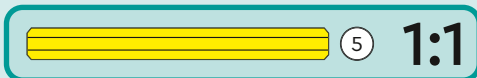
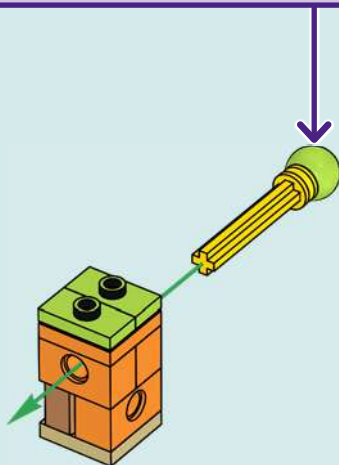
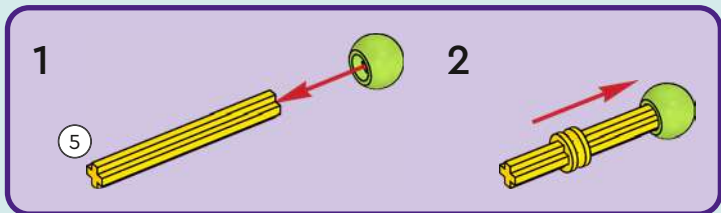



1x

7

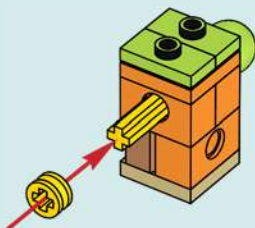

1x

8



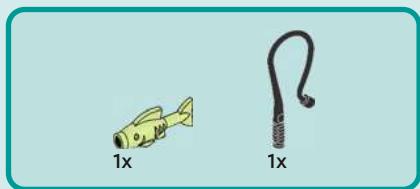

9

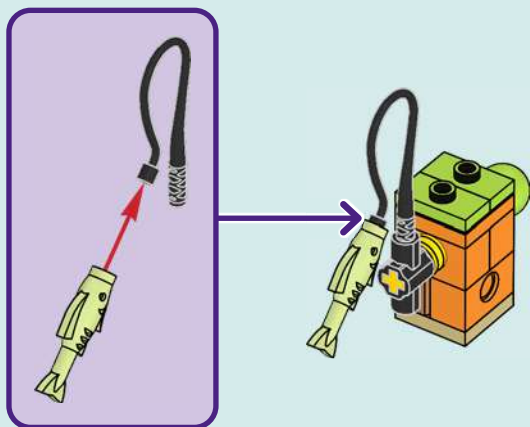



1x

10

CHURRO



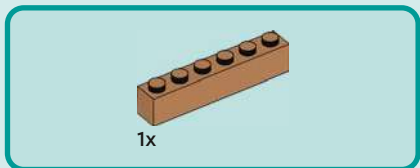

1x

1

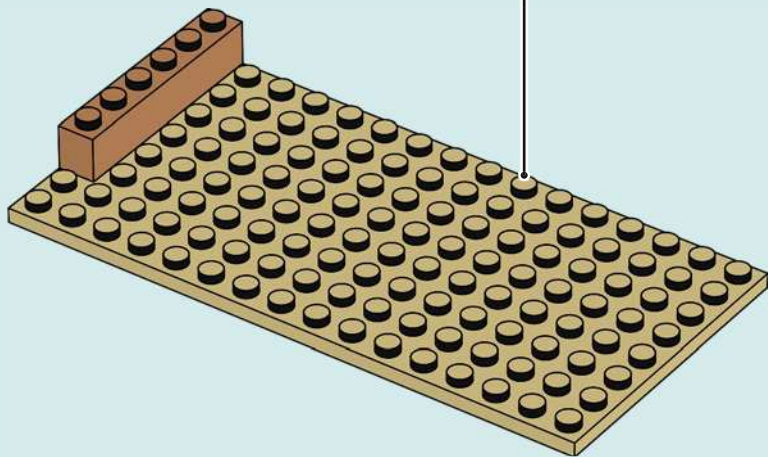



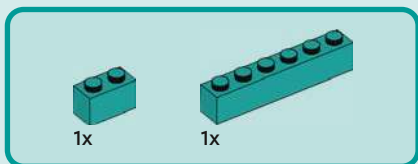

2

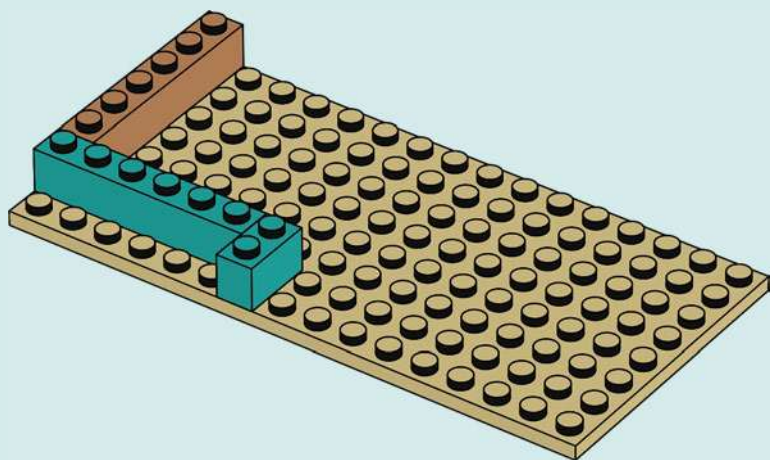



1x



2x

3

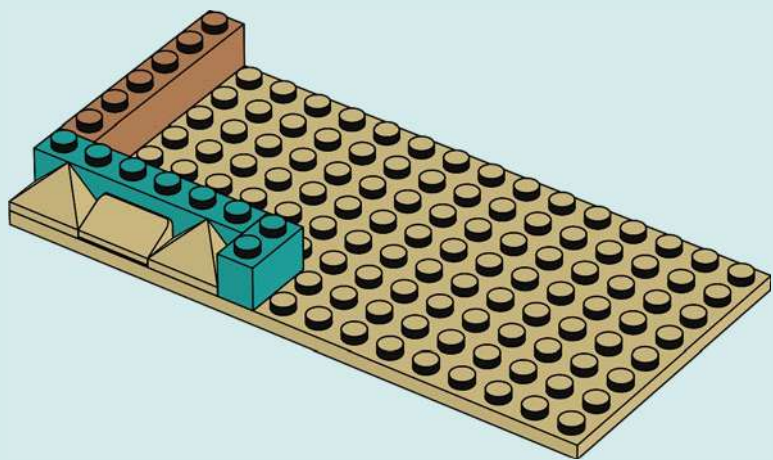

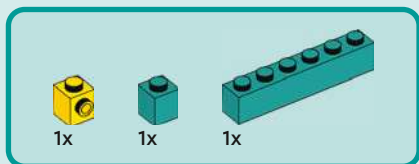

4

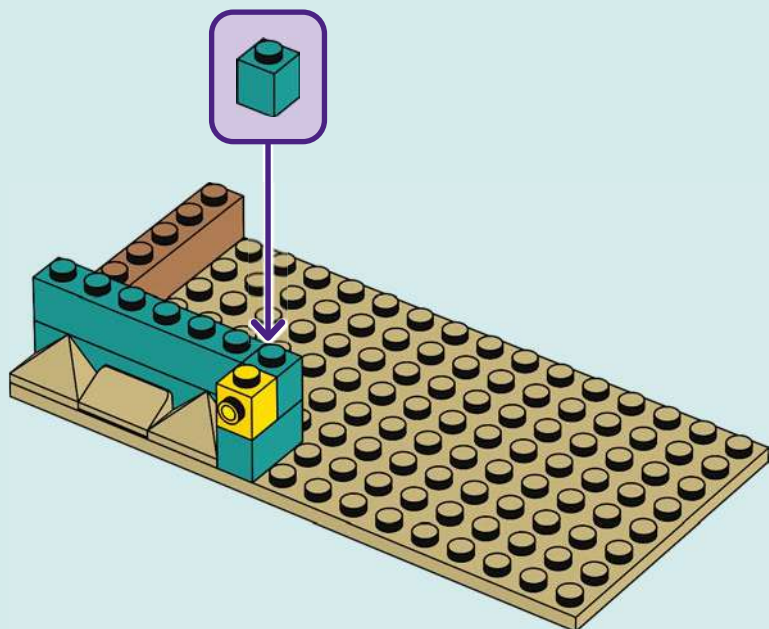

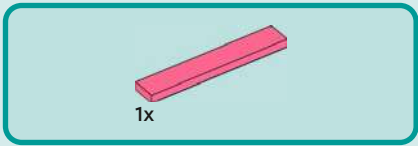

5

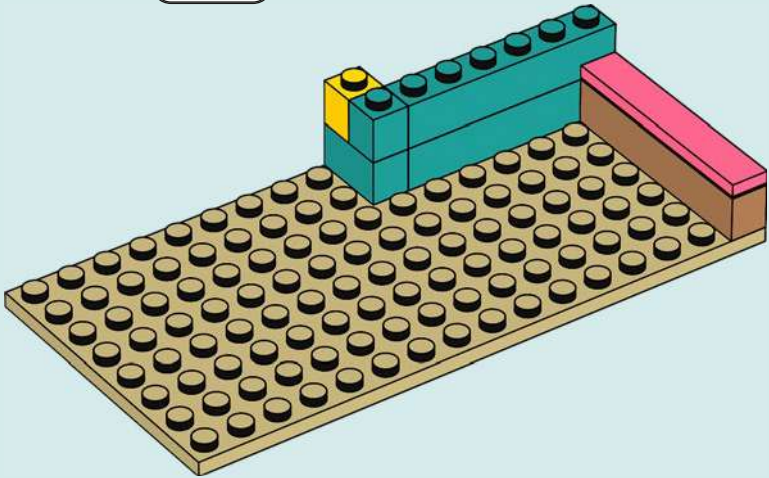



2x

6

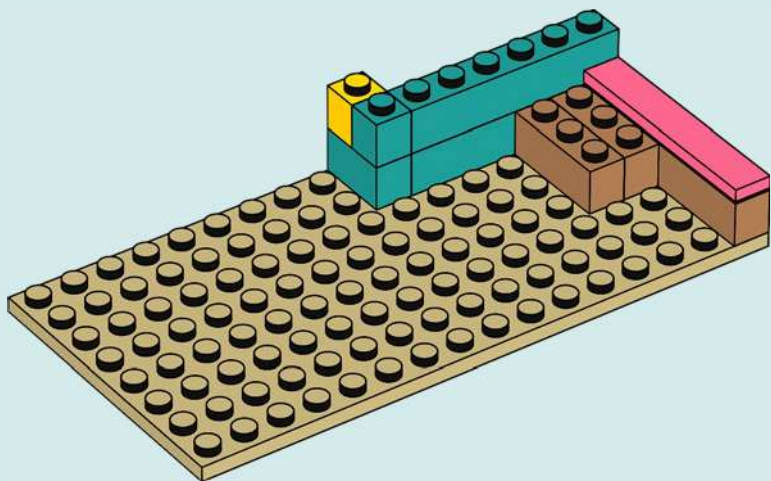

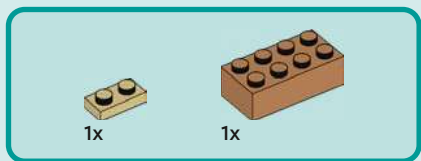

7

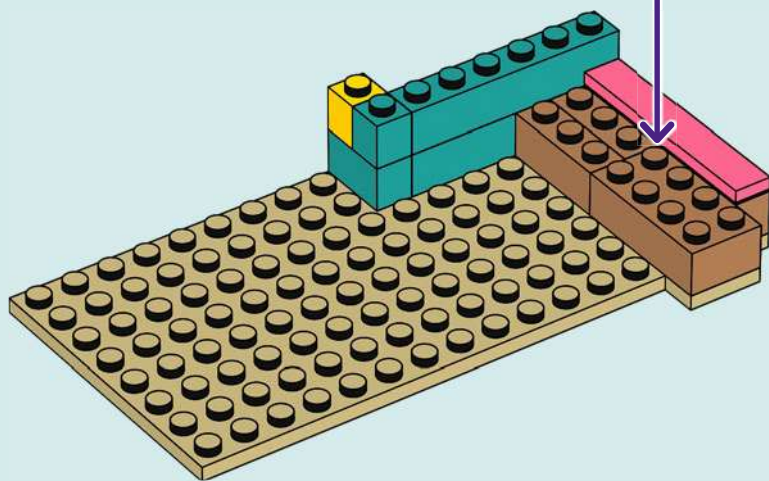
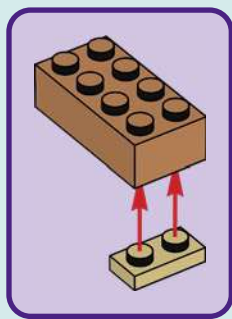



1x



1x



1x

8

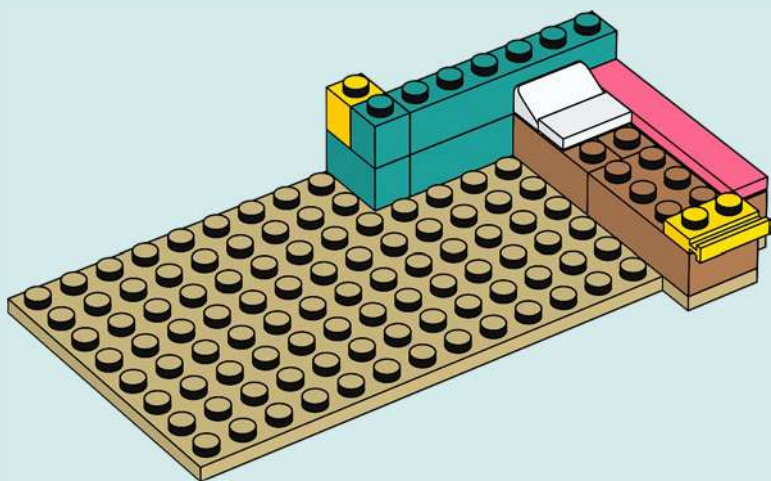

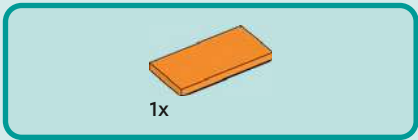

9

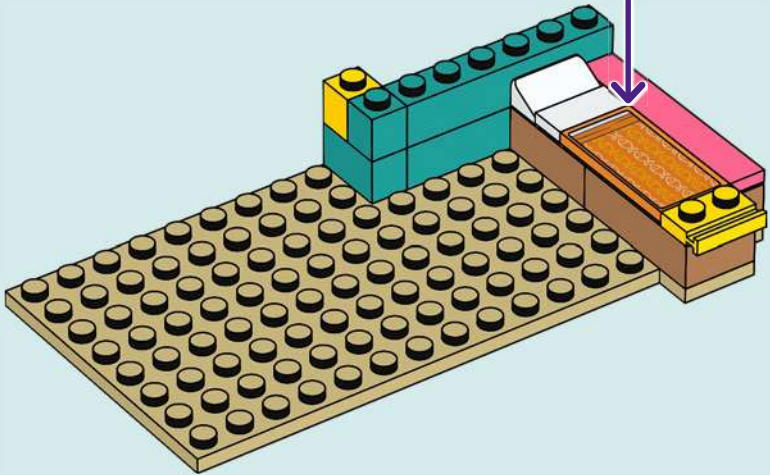
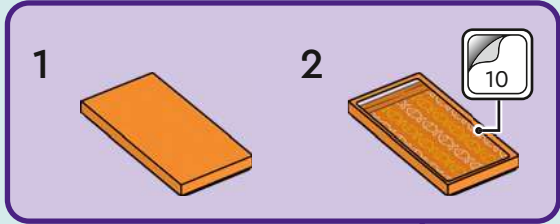



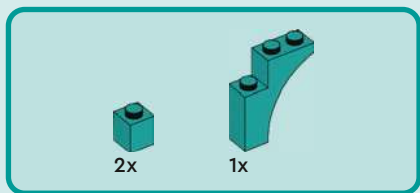

10

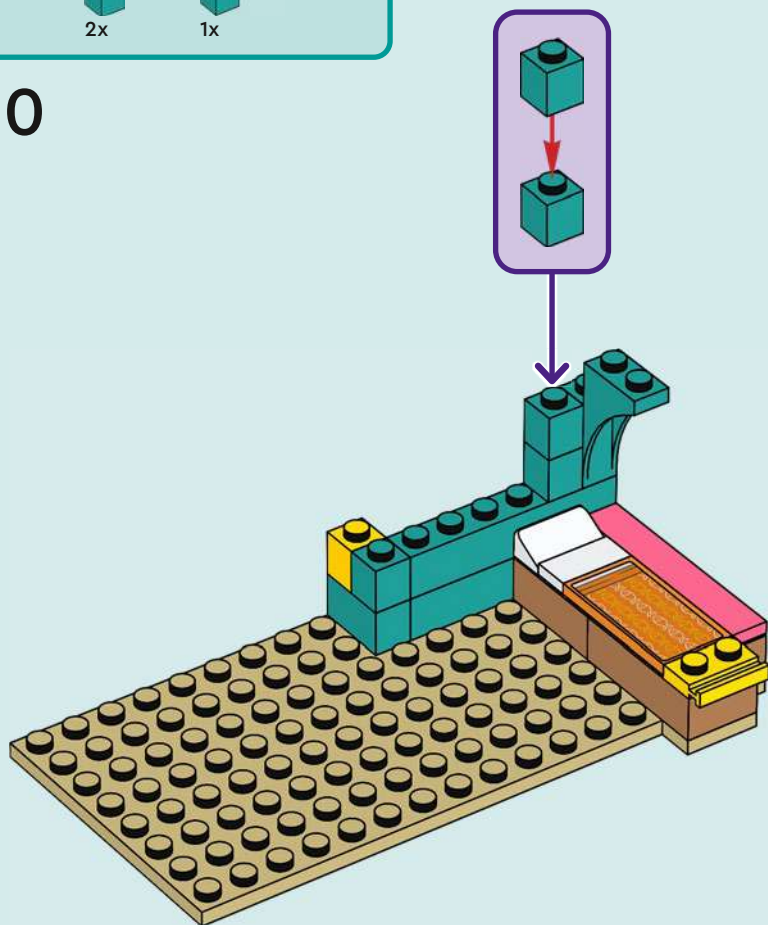

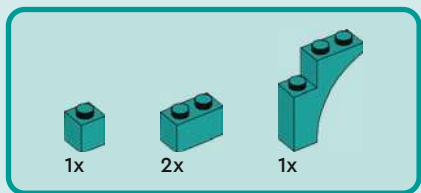

11

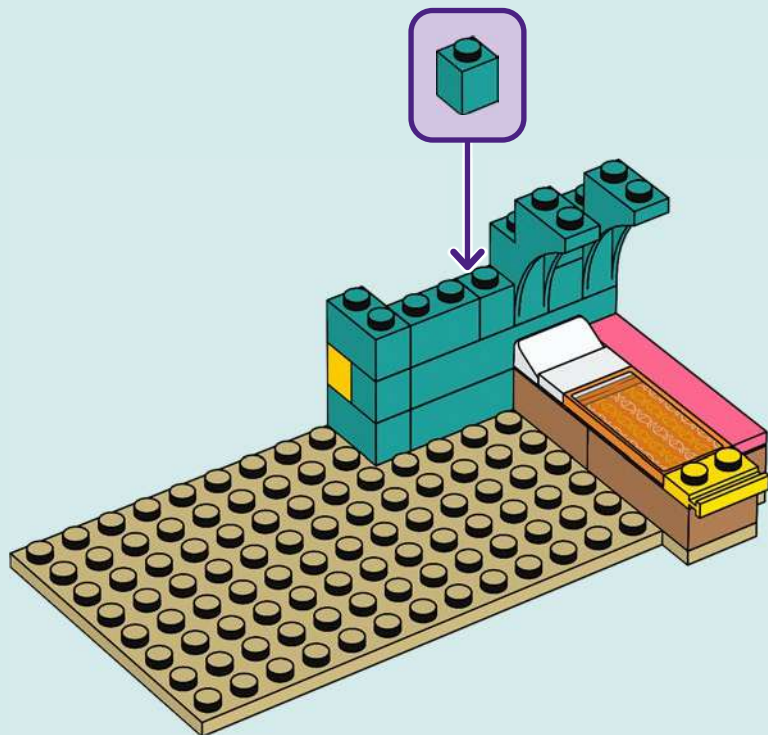



1x



2x

# 12

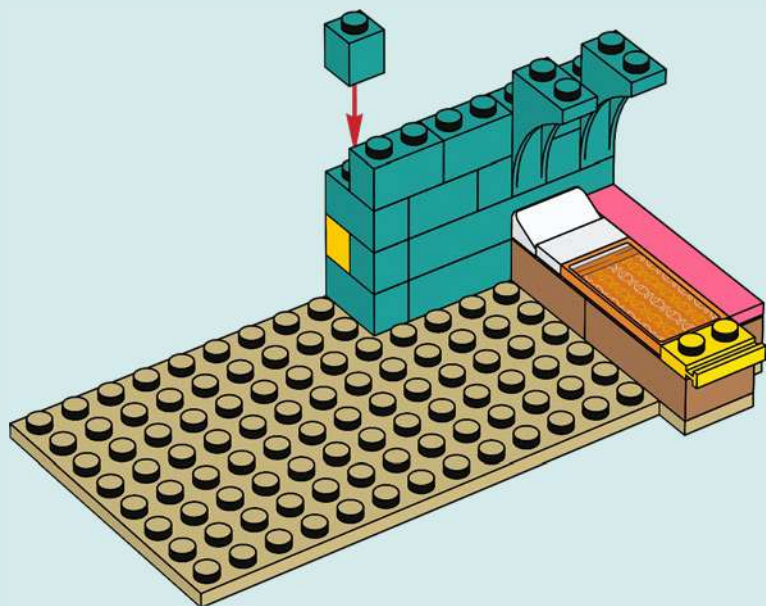

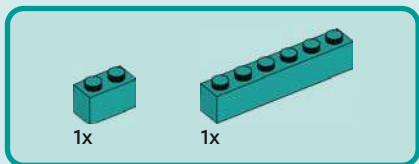

13

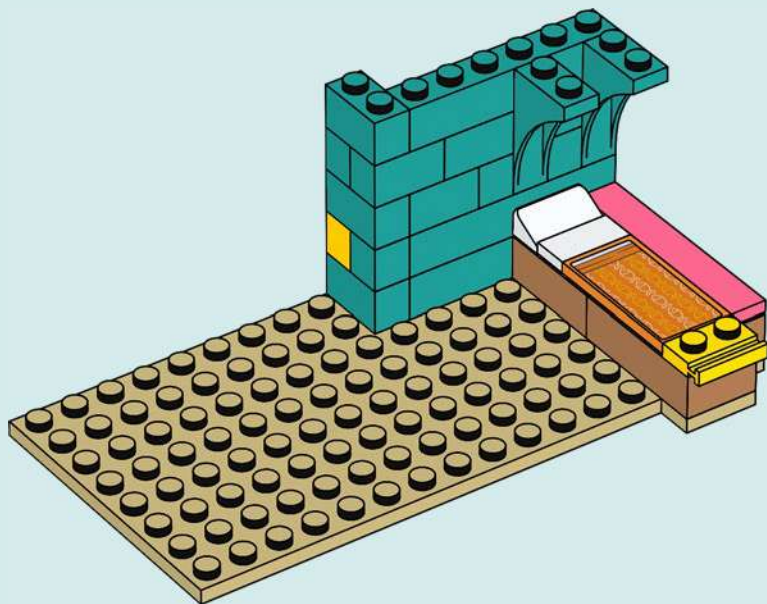

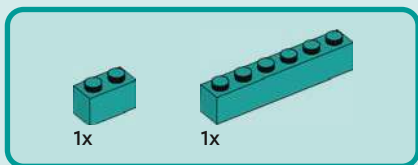

14

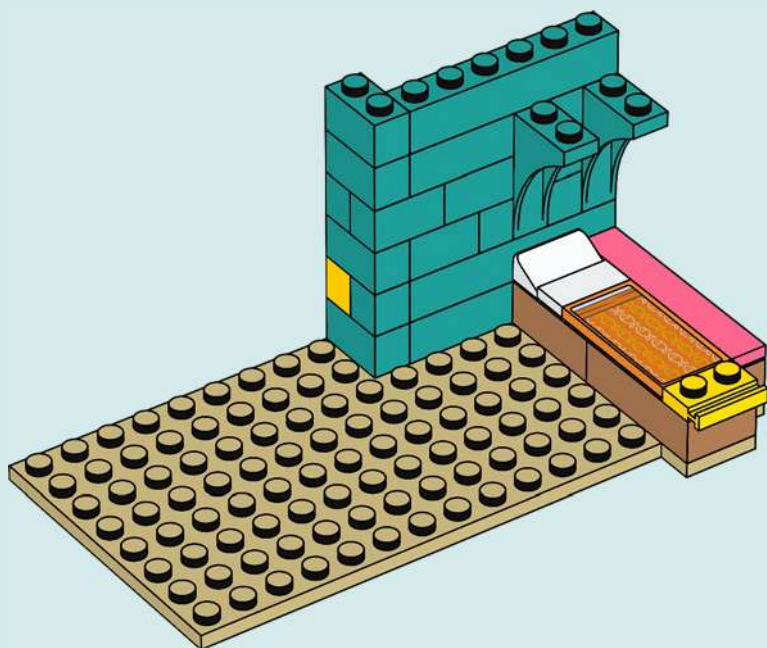

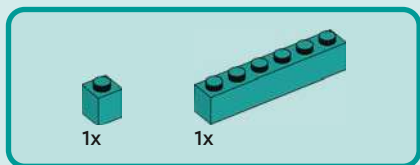

15

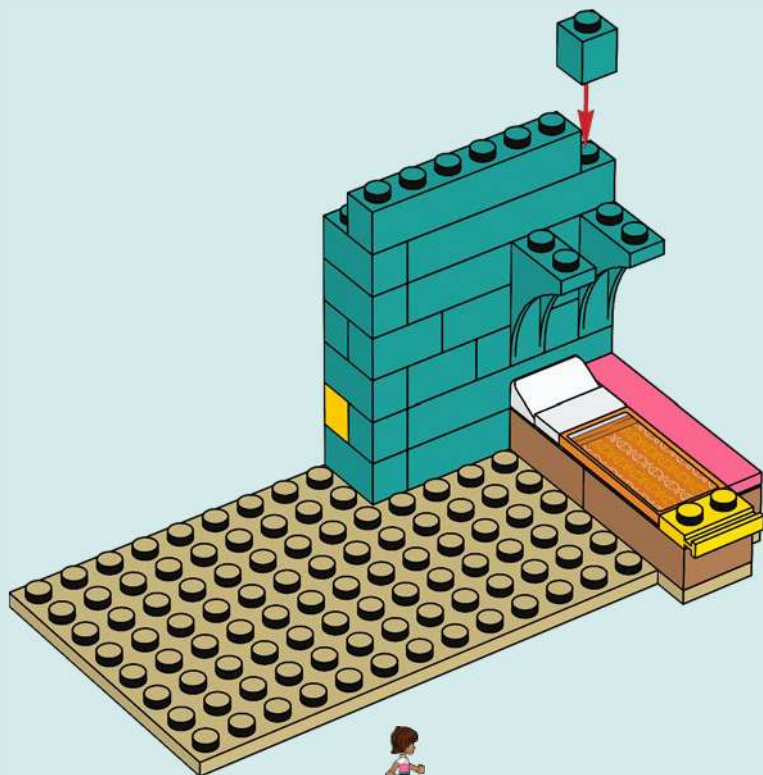



2x



2x

16

1

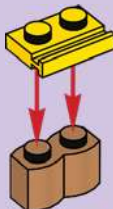

2

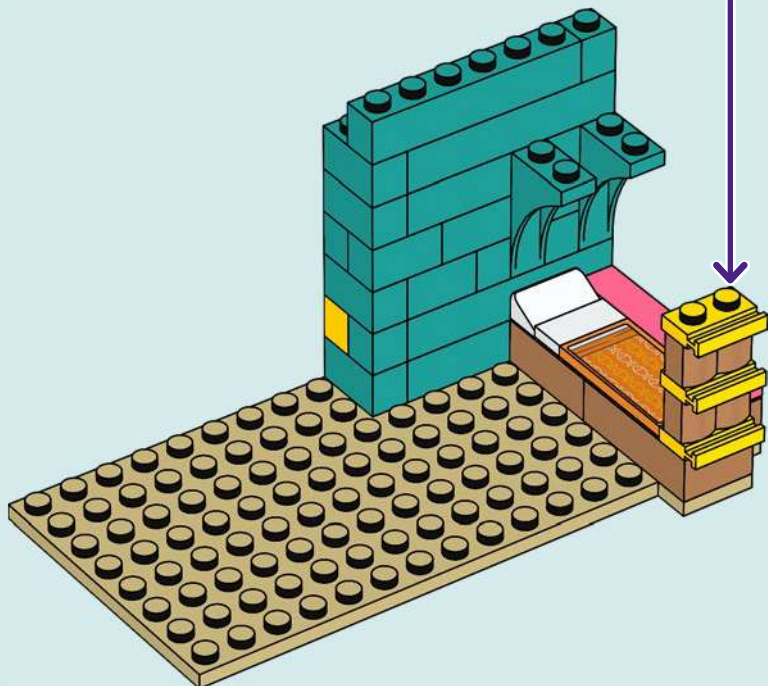
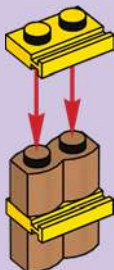



1x

17

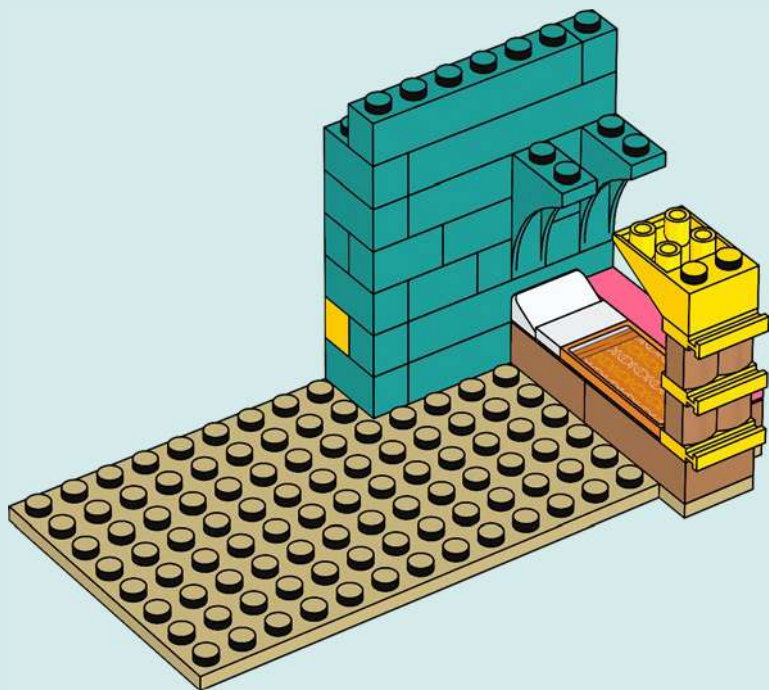



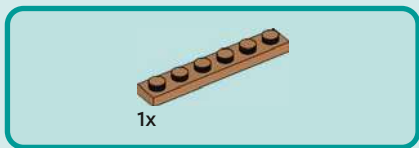

18

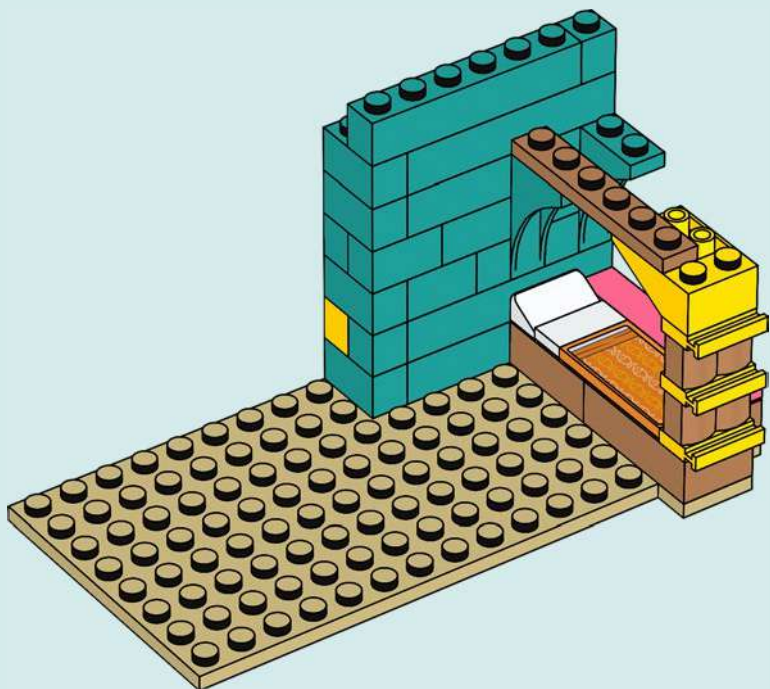



1x

19

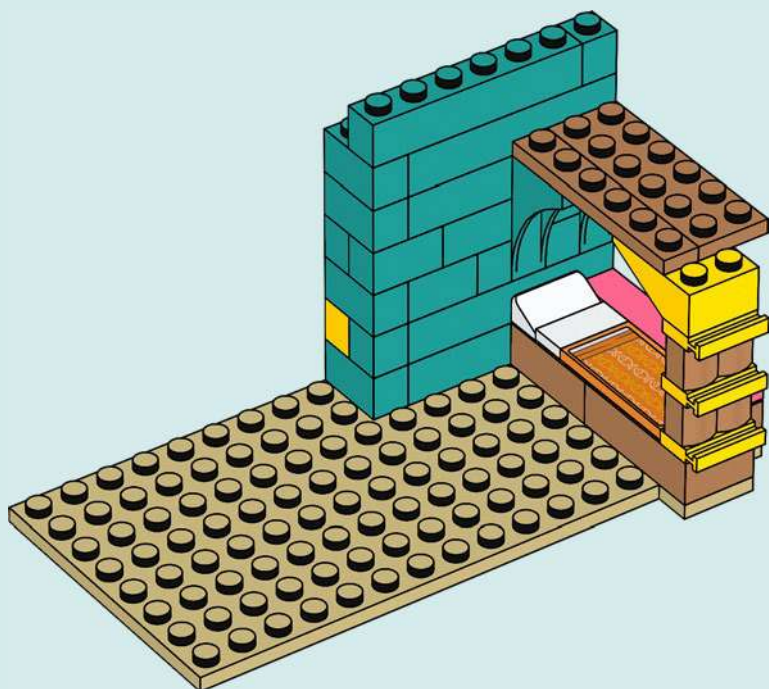

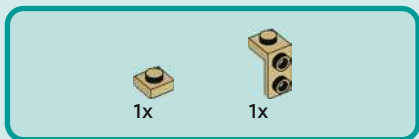

20

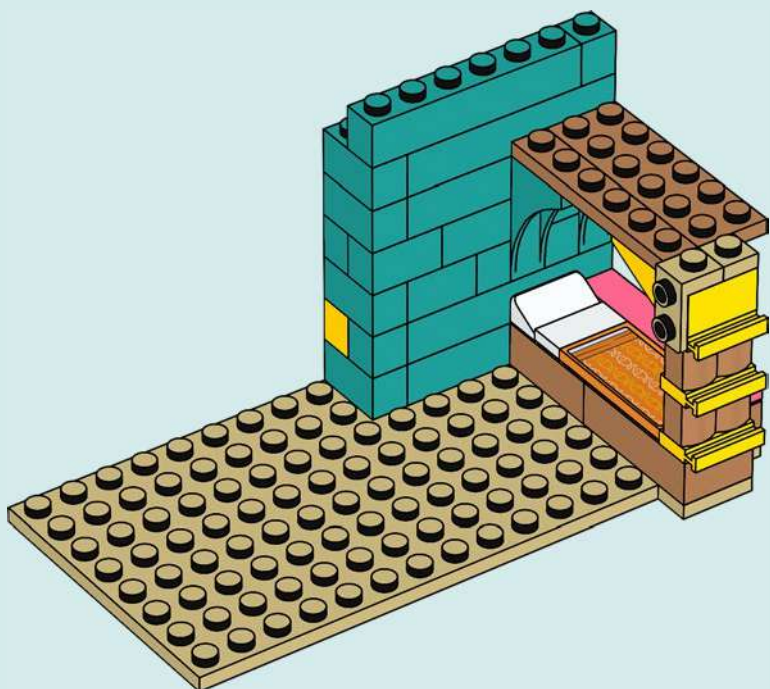



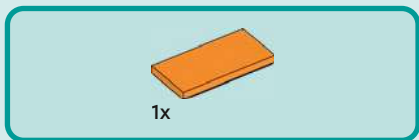

22

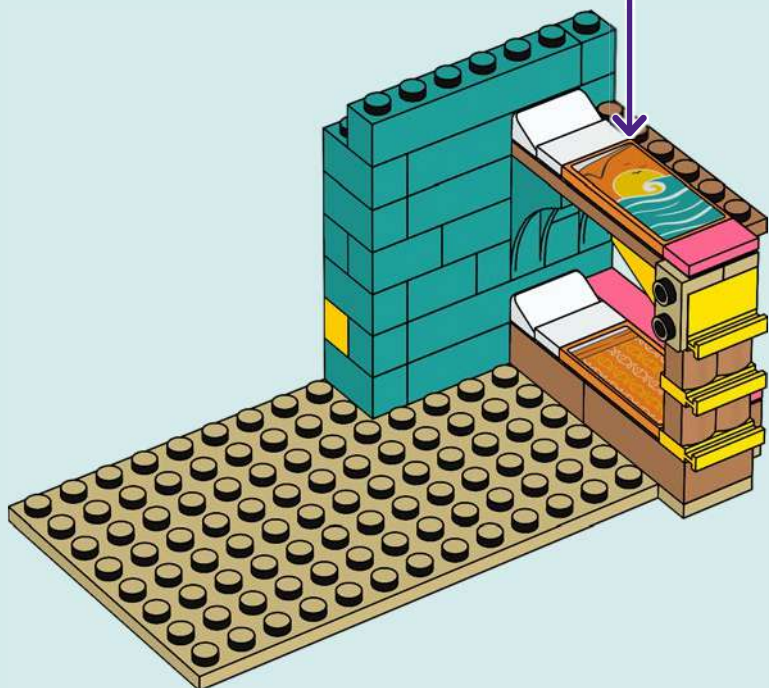
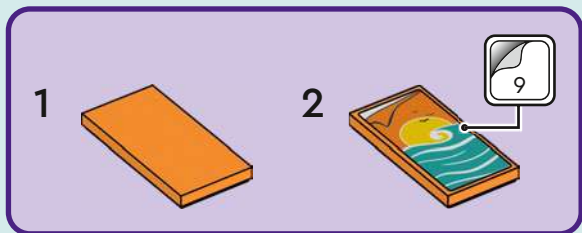



3x

# 23

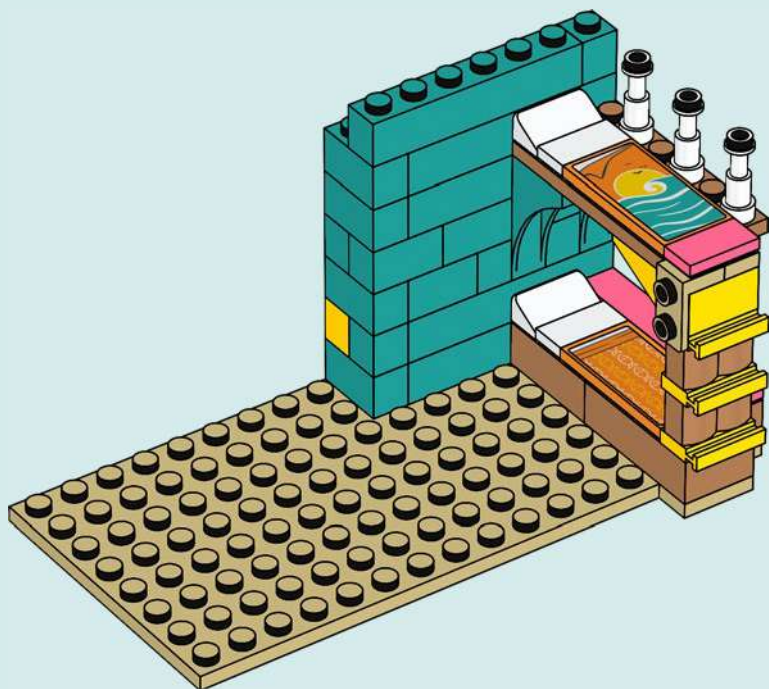

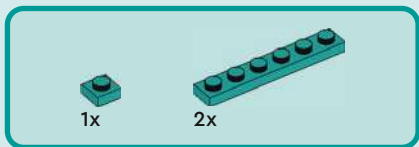

24

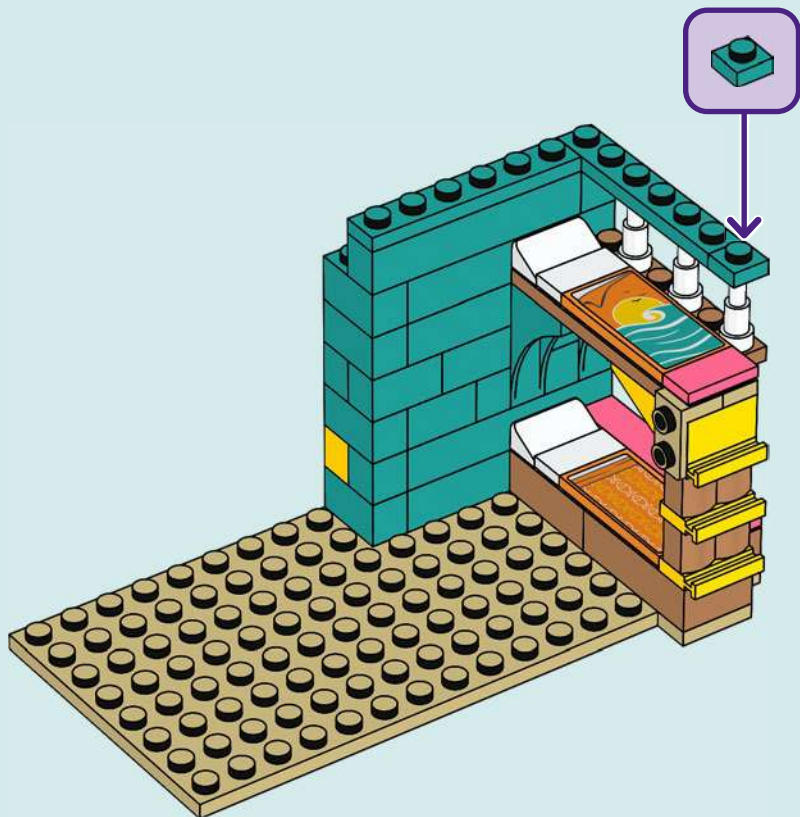



2x

25

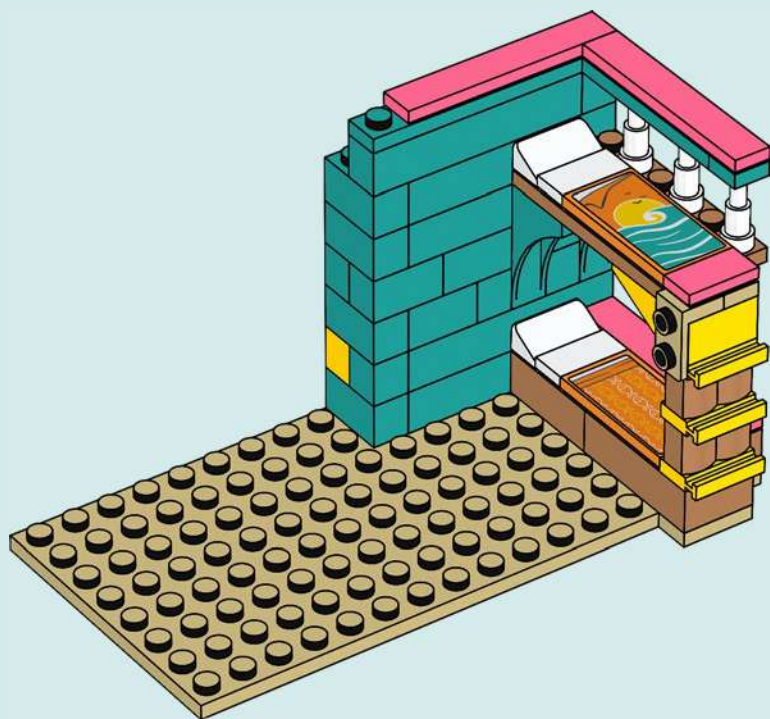





1x

26

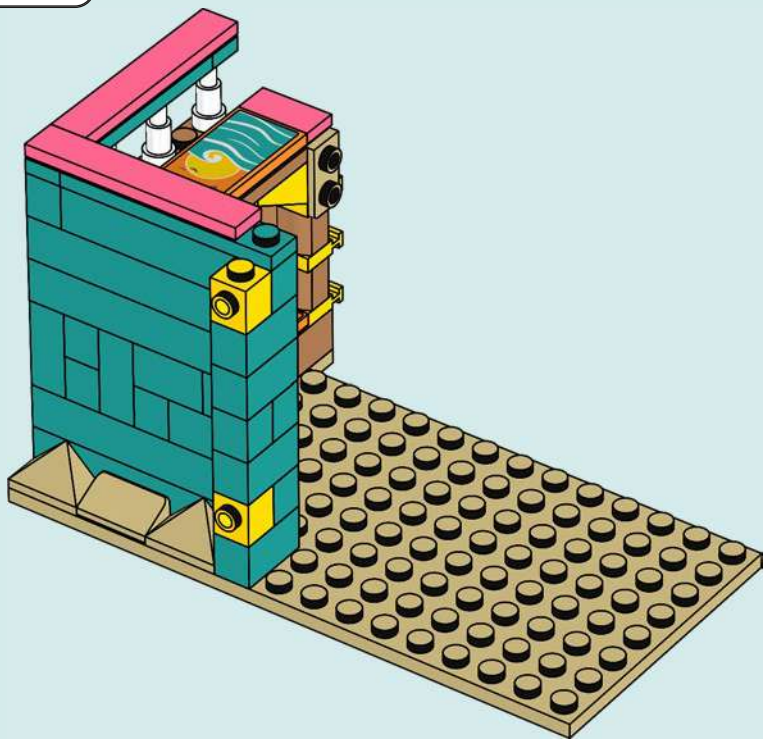

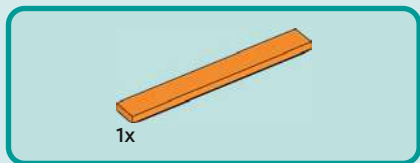

27



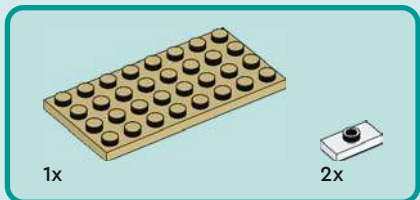

28

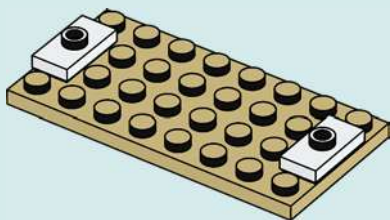



1x

# 29

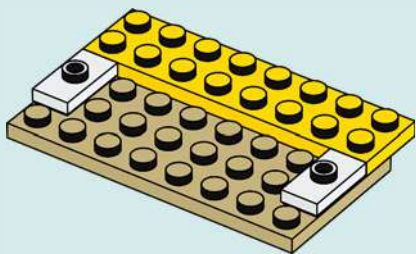

30

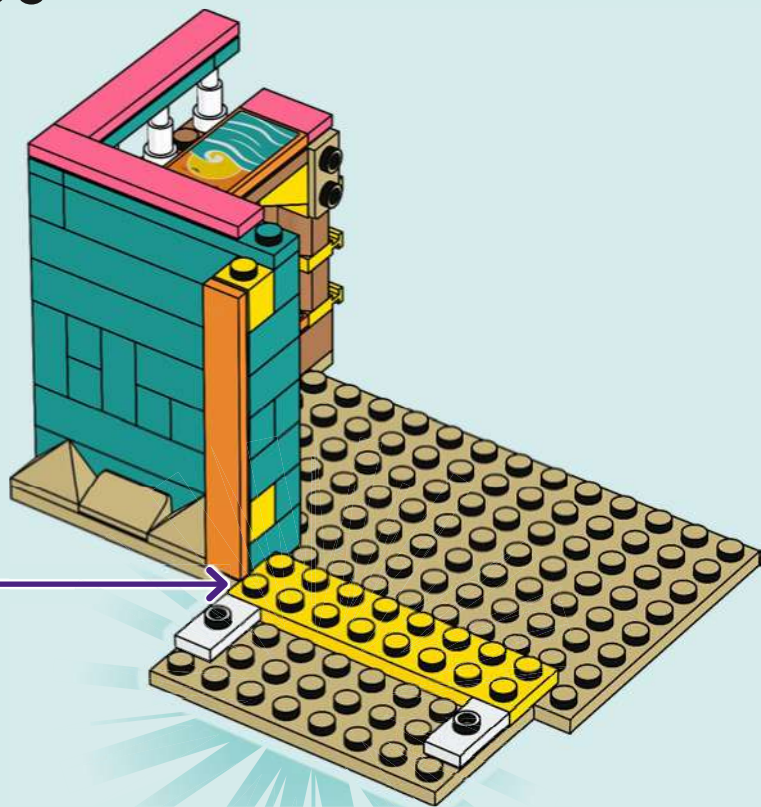



1x

# 31

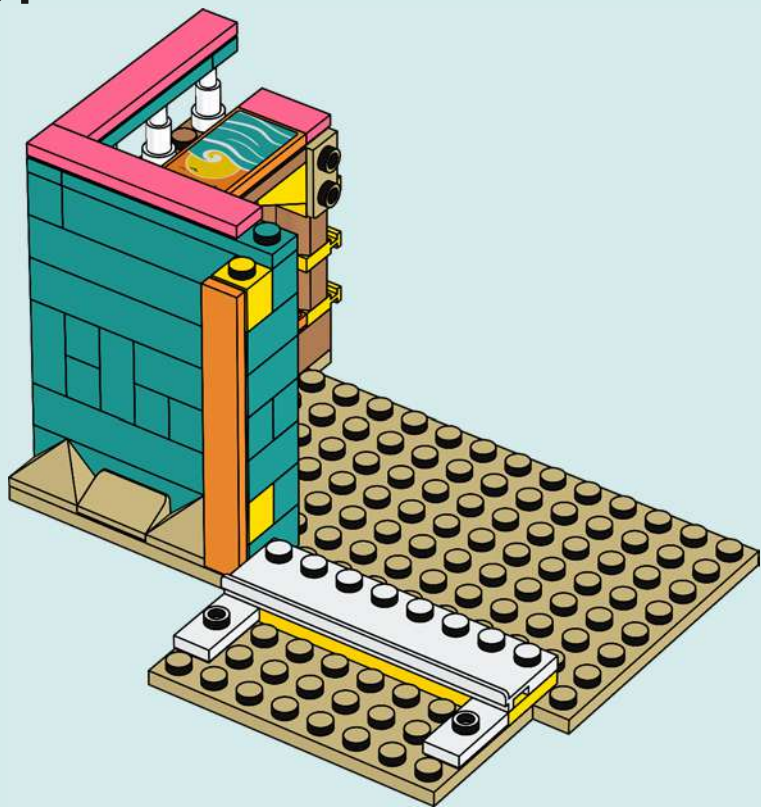



1x

32

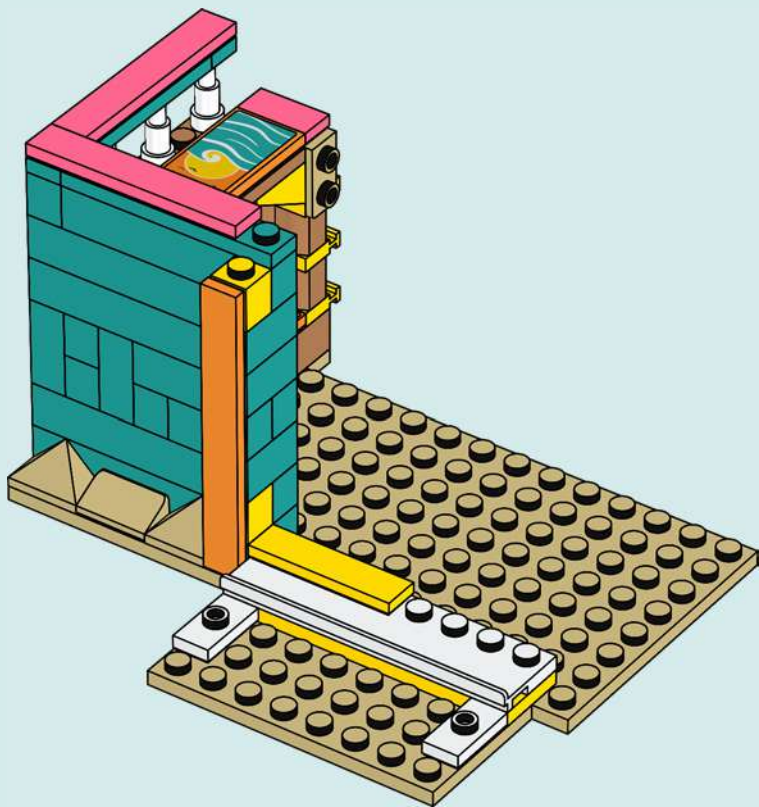

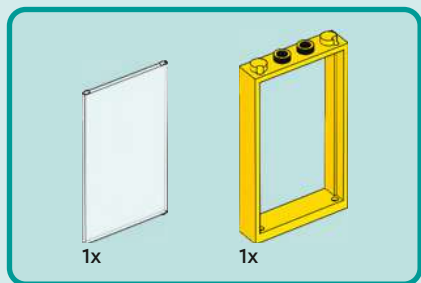

# 33

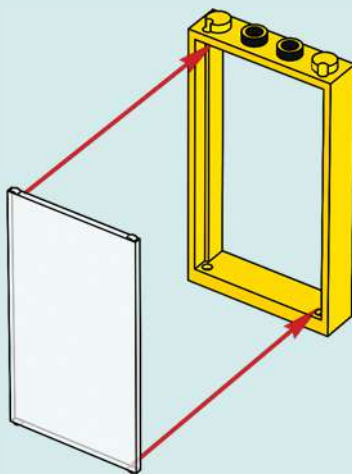



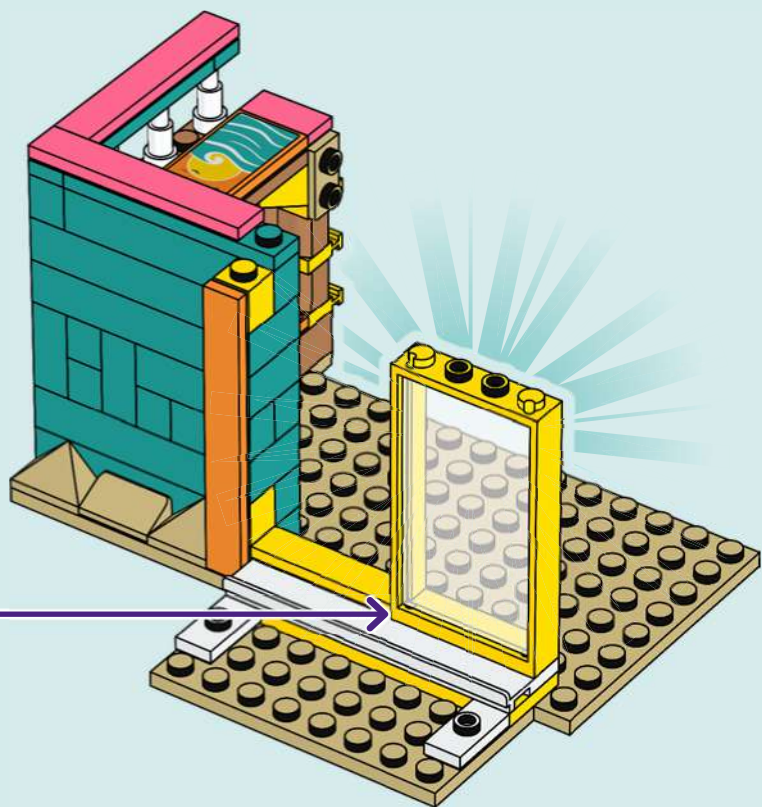



1x



1x

# 34

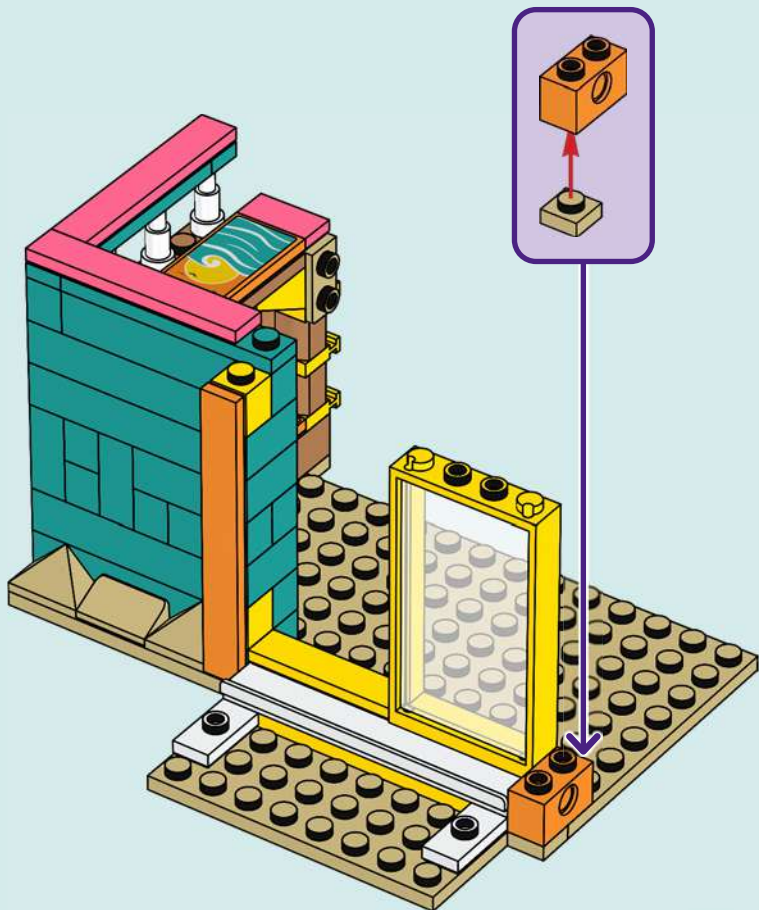



3x

35

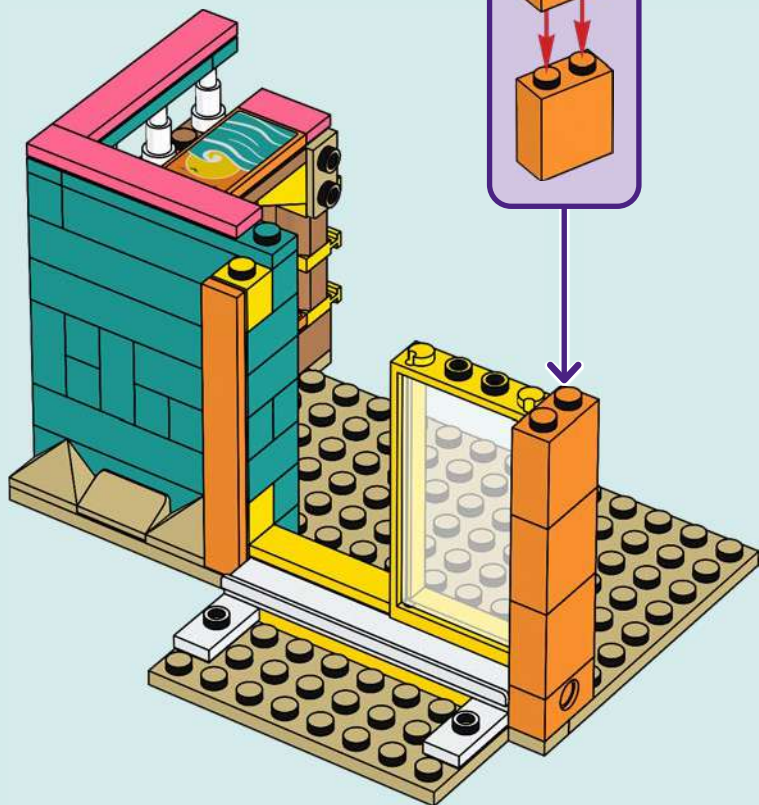

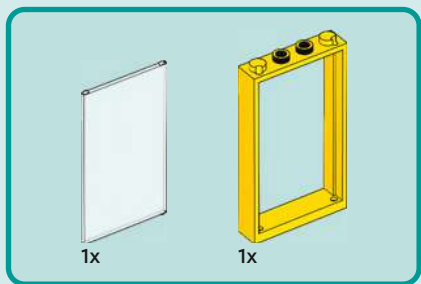

36

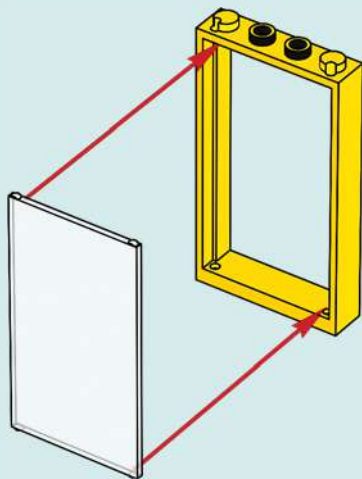

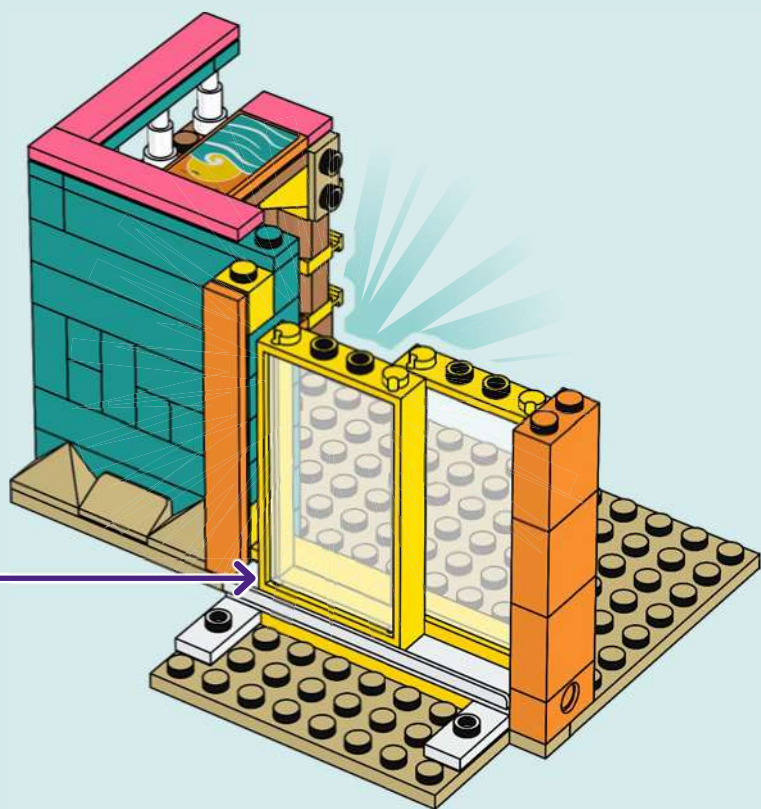

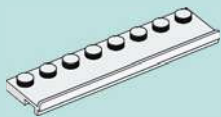

1x

# 37

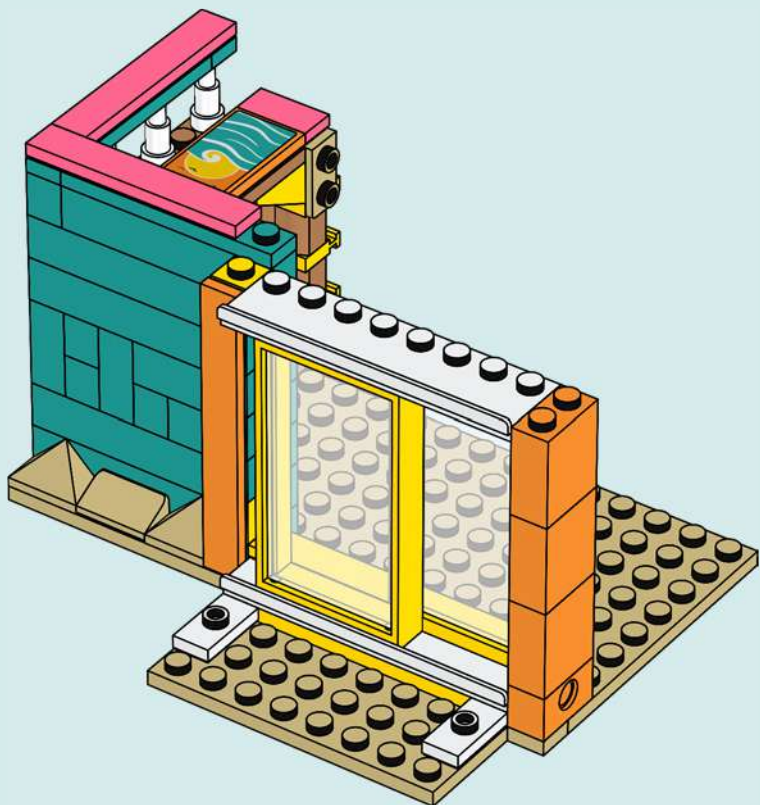



1x

38

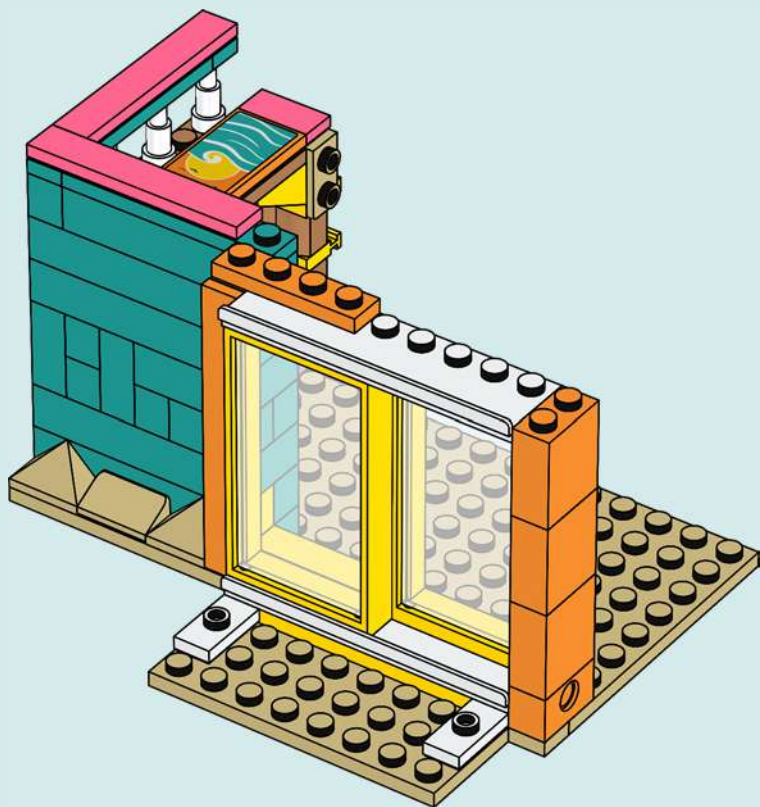



1x



1x

# 39

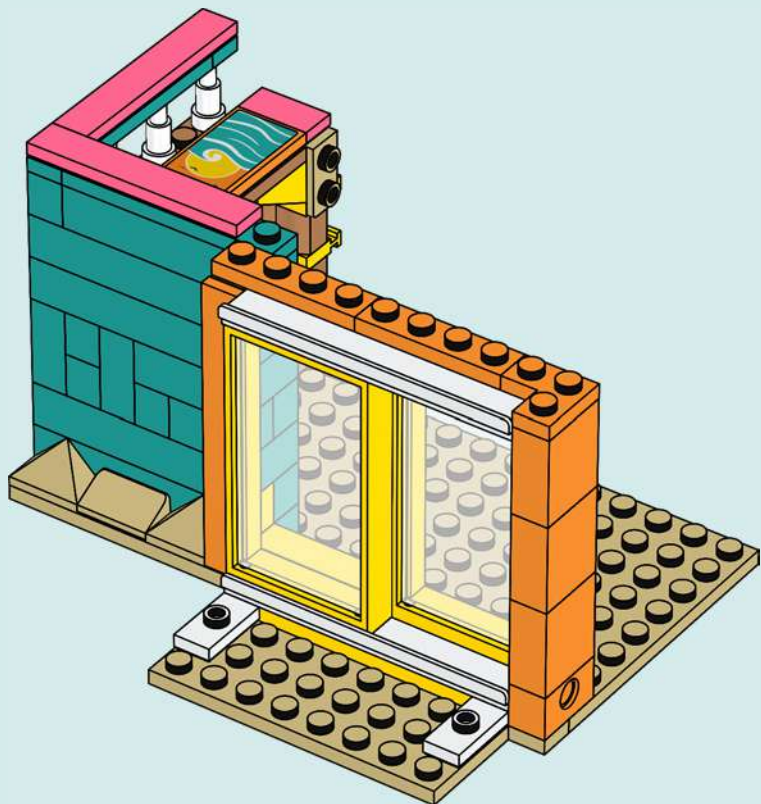



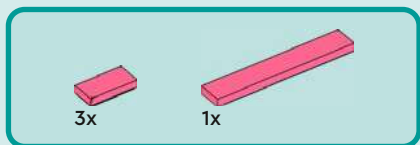

40

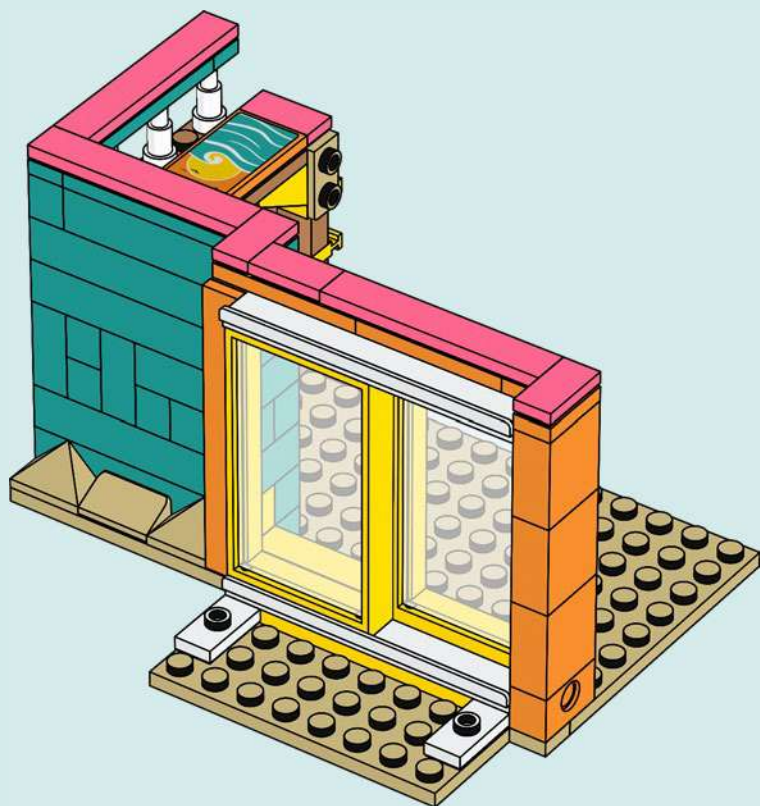

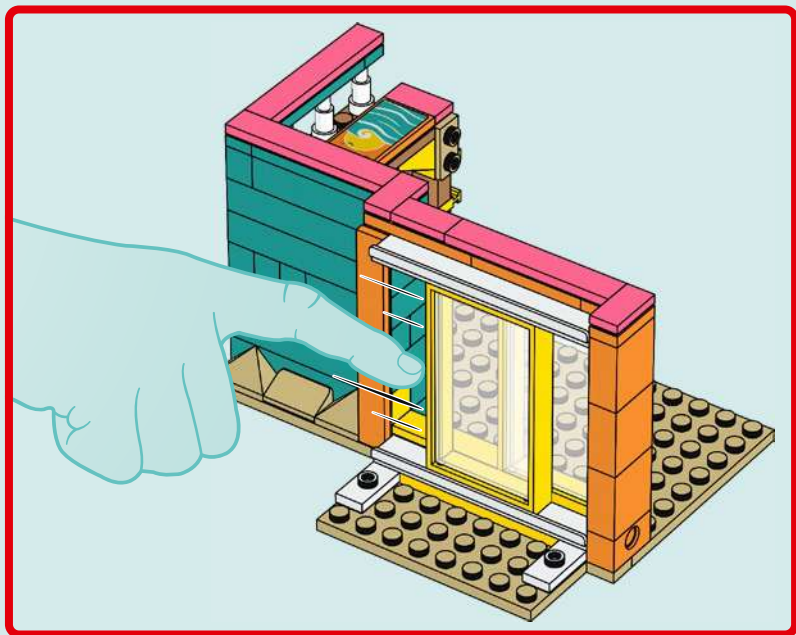



1x

# 41

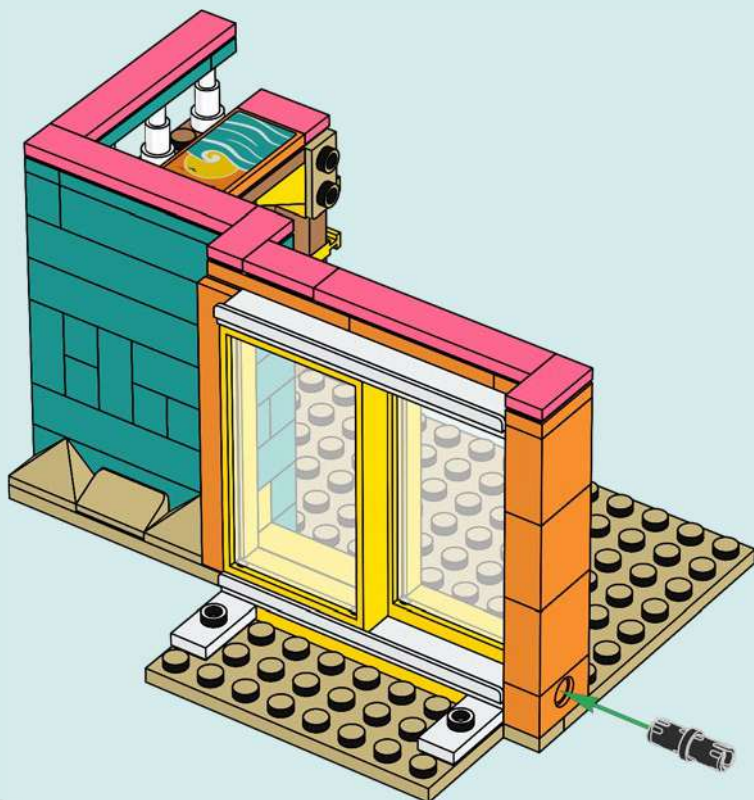



2x

42

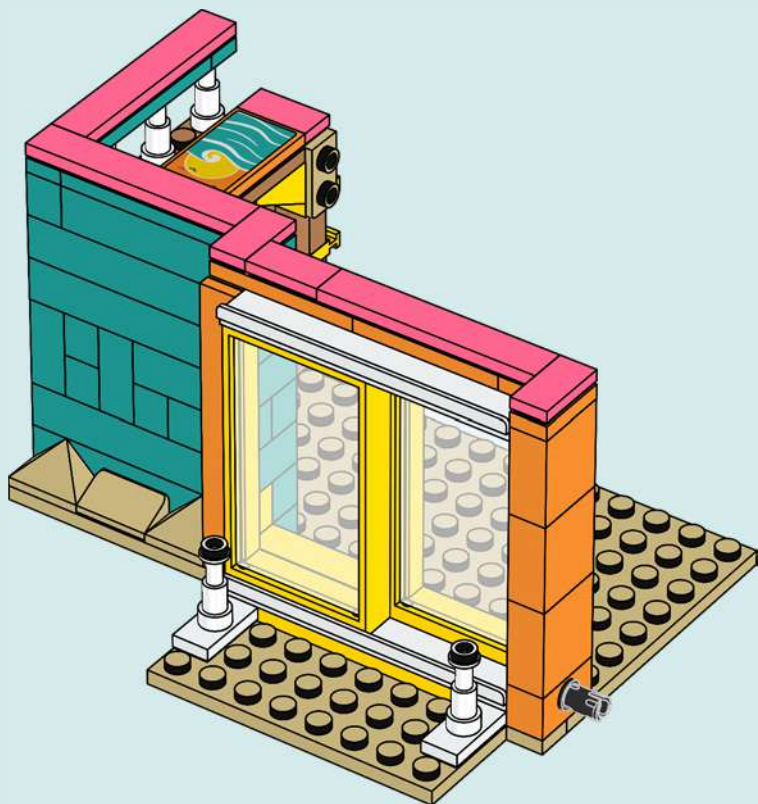



2x

# 43

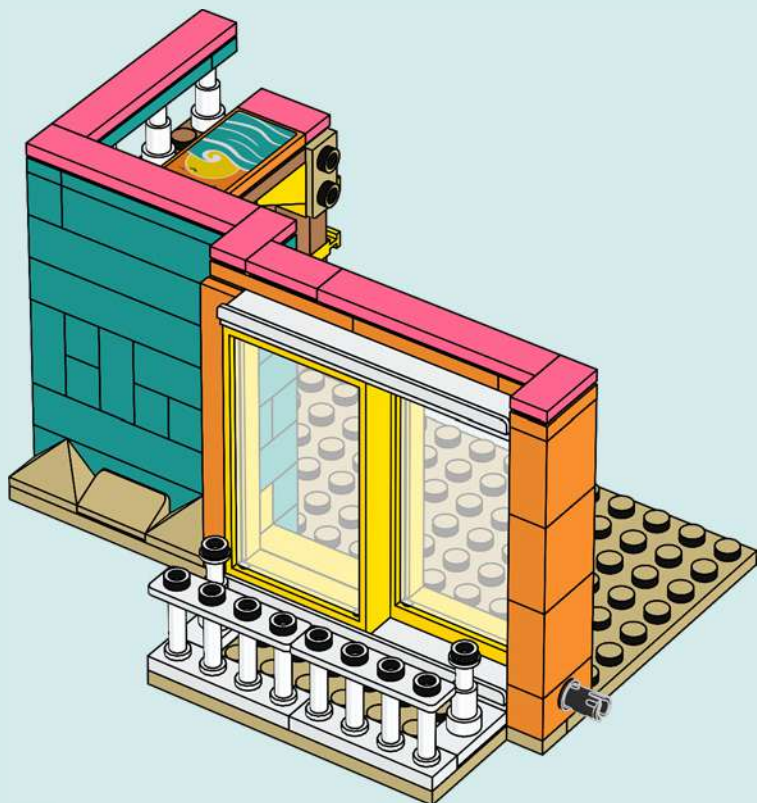



2x

44

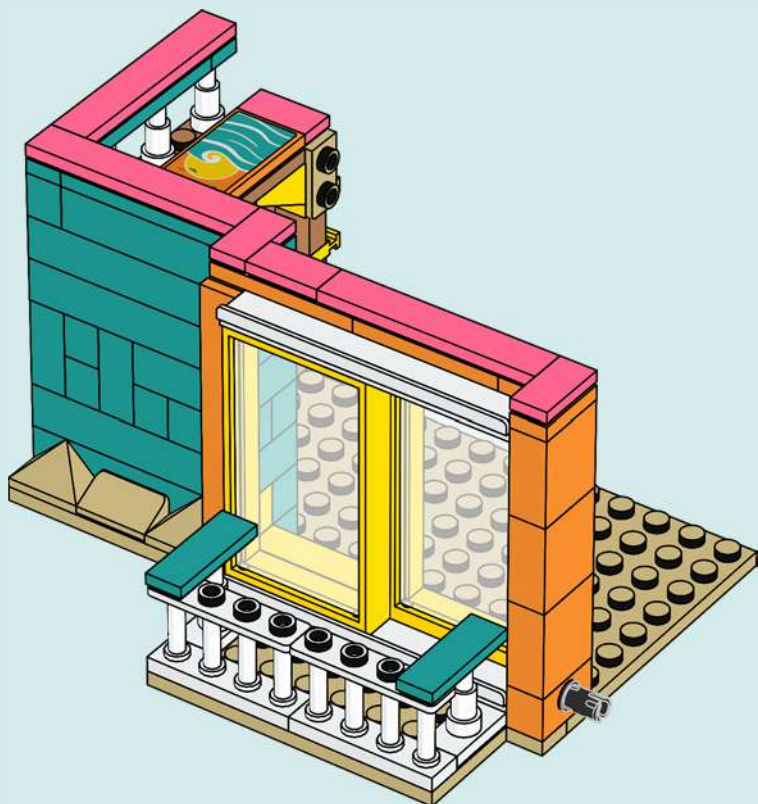



3x

# 45

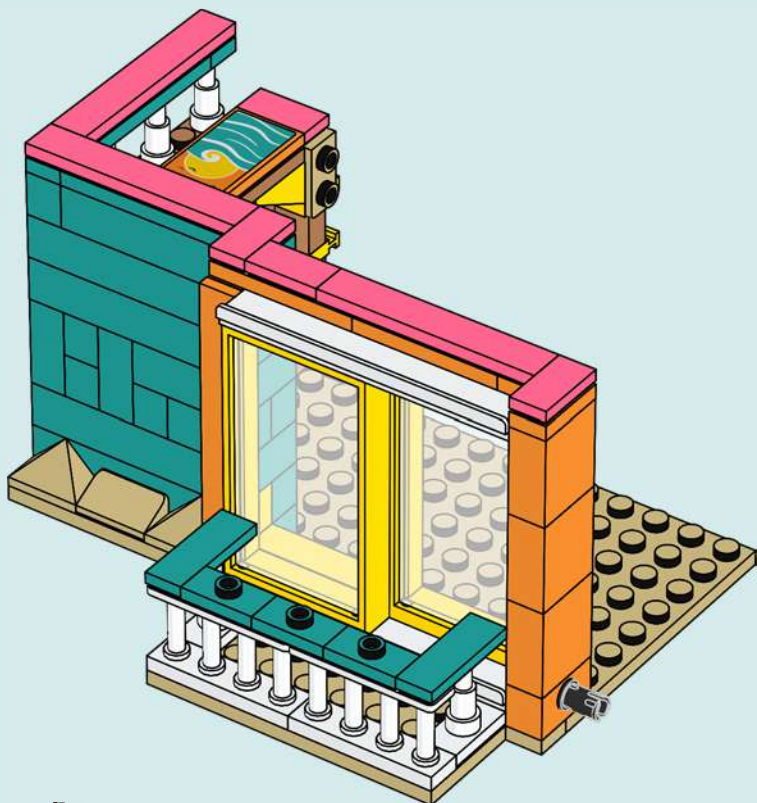



1x



1x

# 46

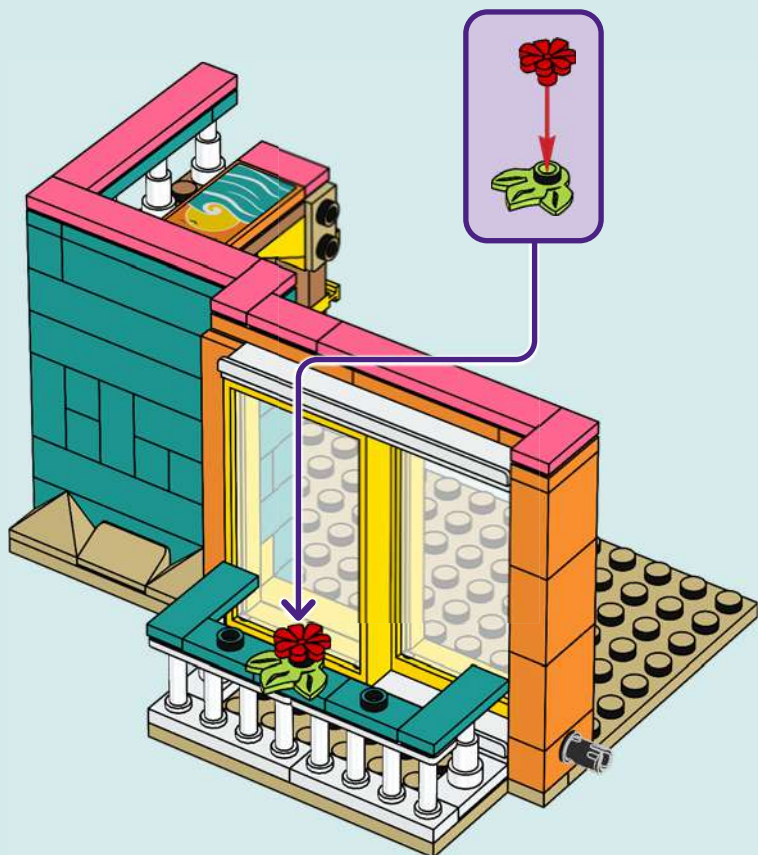





1x



1x

47





1x



1x

# 48

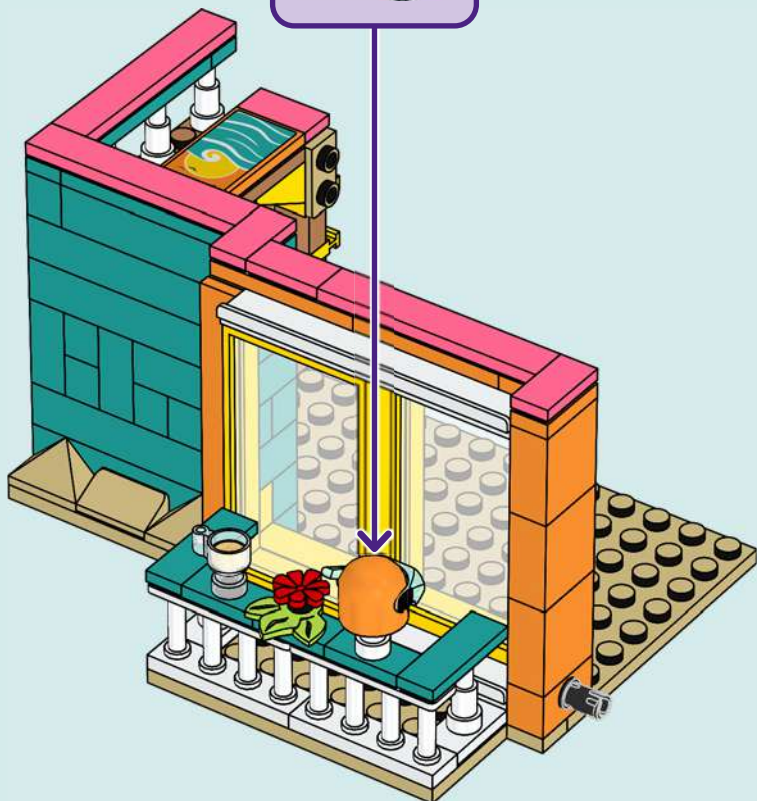



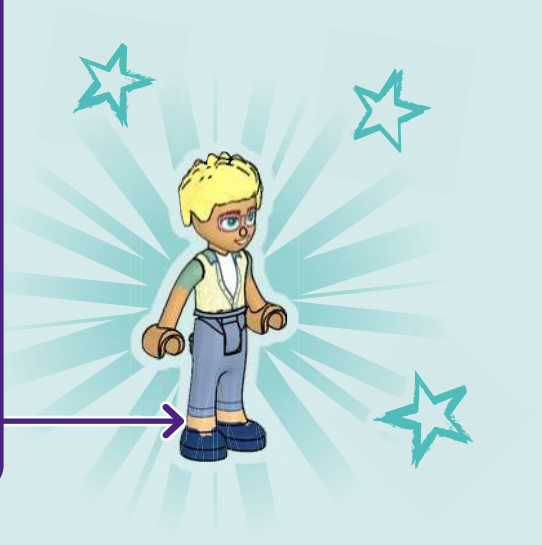
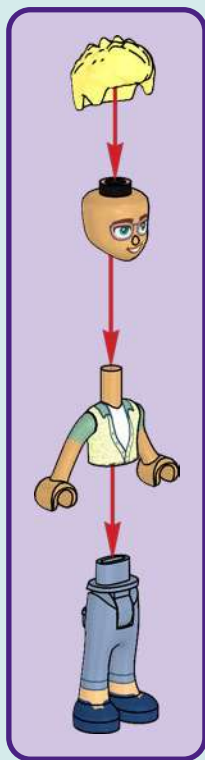

OLLY





2x



2x

49



2x





1x



1x



2x



1x

# 50

1



2

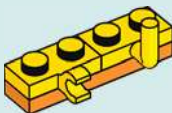

3



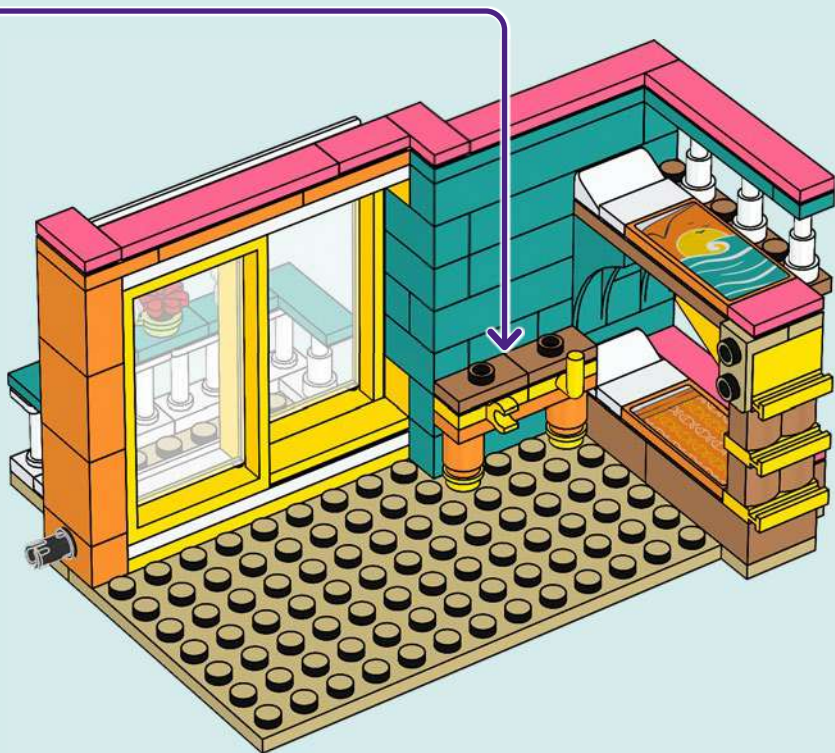





1x



1x



1x

# 51

1

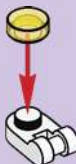

2





2x



1x

# 52

1



2

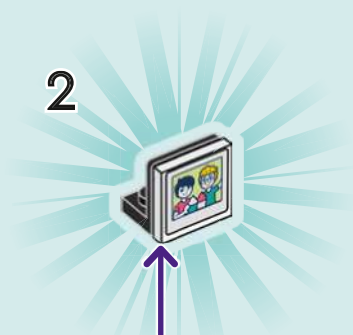

1



2



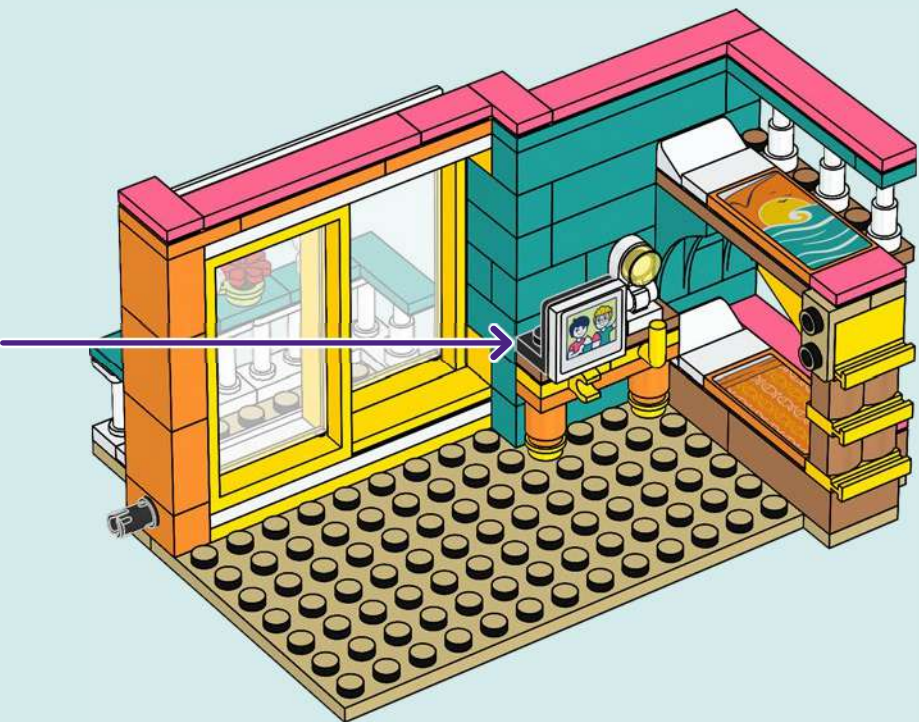
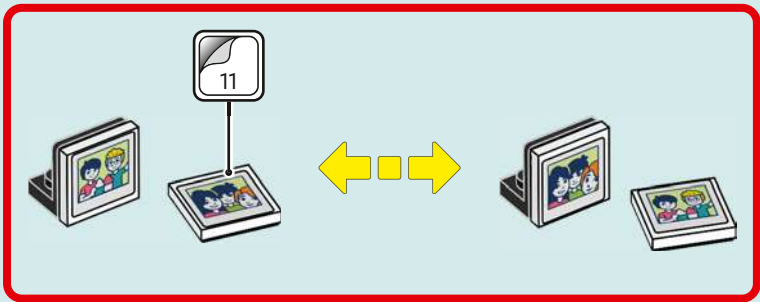



1x

# 53

1



2



5





1x



1x

# 54



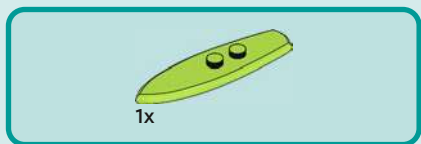

55

1



2

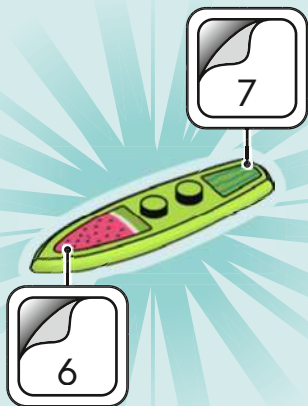





1x



1x



1x

# 56

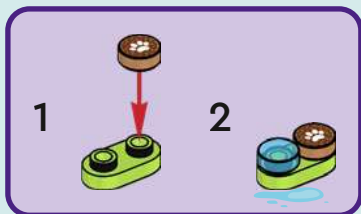





1x

57





1x



1x

# 58

1

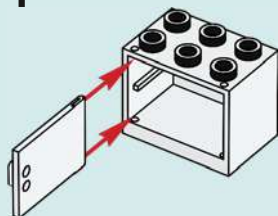

2







1x



1x



1x



1x

# 59

1

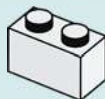

2



3







1x



1x

# 60





2x

61





2x

62







# 63

1



2



3



4

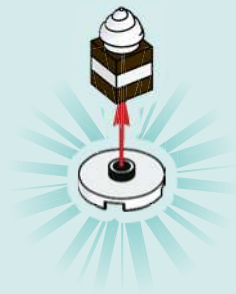





1x



1x

# 64





1x



1x

# 65





1x



2x

# 66

1



2





2x

67

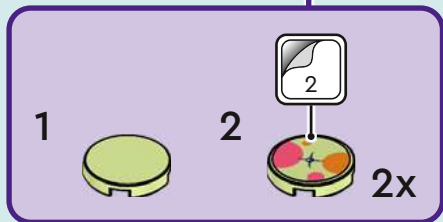



68

1

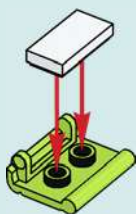

2

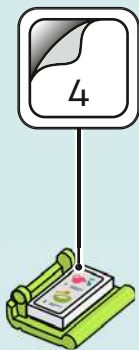

3



4

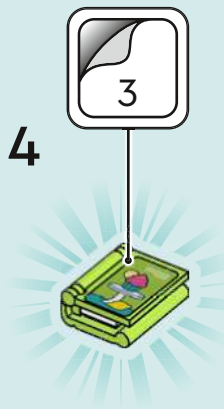







# 69



1



2



3



4



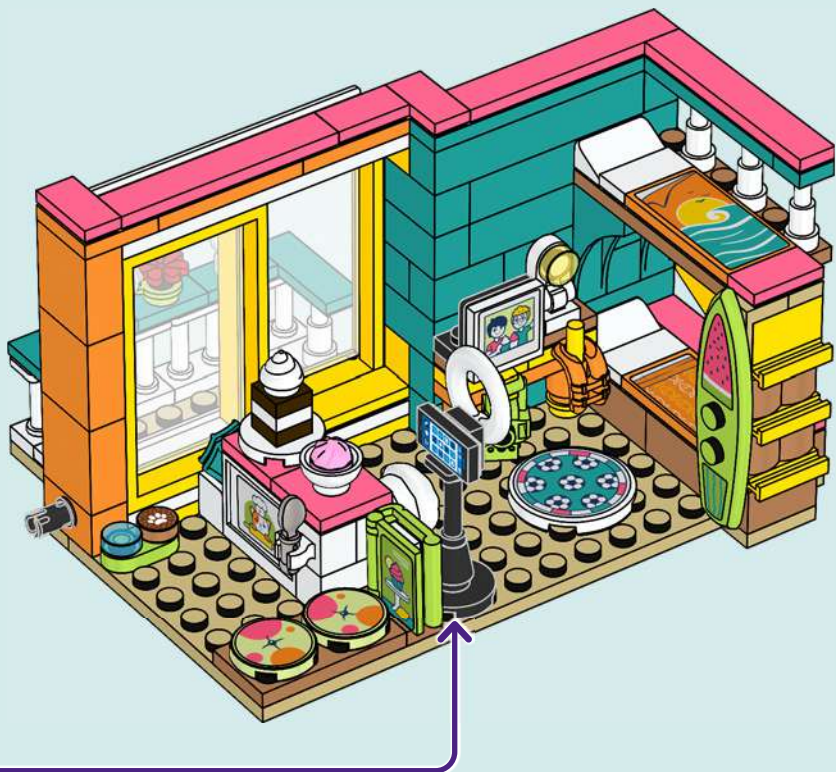

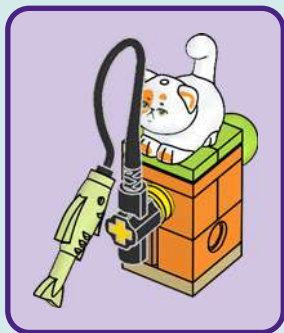



1





2x

2

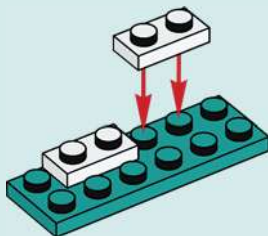

2x

3

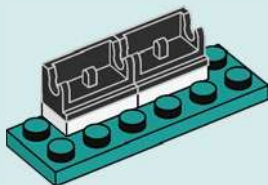



2x

4

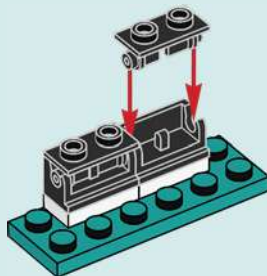

1x

5



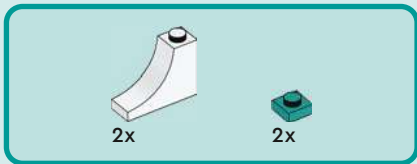

6

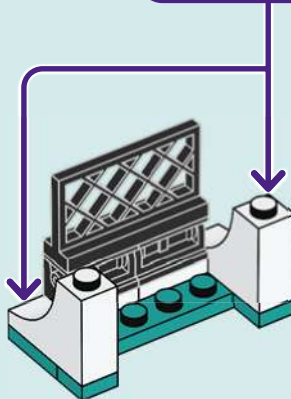
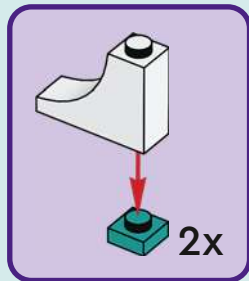

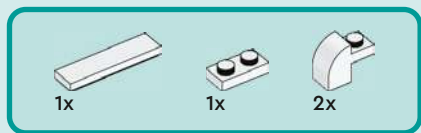

7

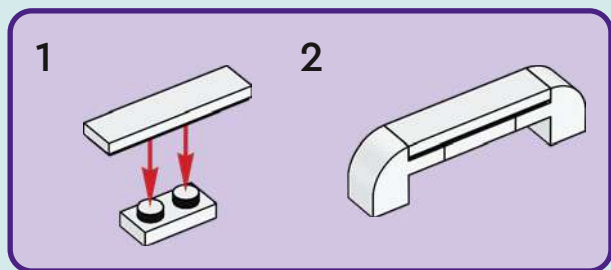

2

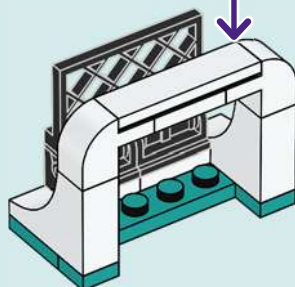
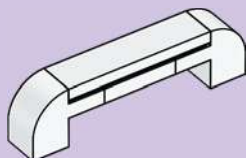



8

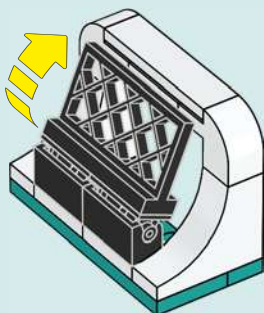

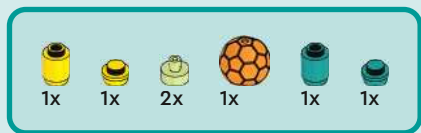

9

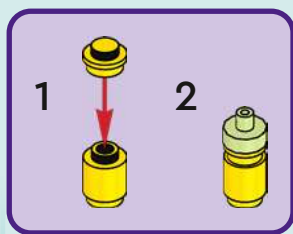
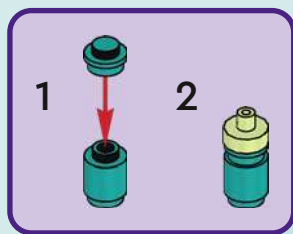

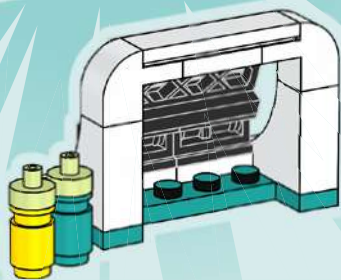



# Friends

PAISLEY

AUTUMN

ALIYA

ZAC



LEO

LIANN

OLLY



NOVA



# Friends

## 41727



## 41741

41738



41730





# Friends

41731



41728



41743





  
1x  
6292800

  
1x  
4558952

  
2x  
302401

  
1x  
6348055

  
1x  
6198979

  
1x  
6321349

  
1x  
6174310

  
1x  
6174937

  
2x  
4547489

  
1x  
6093053

  
1x  
6428858

  
3x  
302301

  
2x  
6285777

  
2x  
6051511

  
1x  
300401

  
1x  
6248490

  
3x  
306901

  
6x  
6070327

  
1x  
4261470

  
1x  
4297083

  
2x  
306801

  
1x  
6300017

  
2x  
6110019

  
1x  
4619665

  
1x  
243101

  
2x  
6047813

  
2x  
4500878

  
1x  
6182260

  
2x  
6271167

  
4x  
614124

  
1x  
306224

  
2x  
4624985

  
1x  
6261356

  
1x  
6313121

  
3x  
4141630

  
1x  
374724

  
1x  
243124

  
2x  
6262947

  
1x  
6130008

  
1x  
303424

  
2x  
6220715

  
1x  
6136310

  
1x  
6295184

  
1x  
6261264

  
4x  
6136553

  
3x  
6078590

  
1x  
4159007

  
1x  
6106027

  
3x  
4118782

  
2x  
4648853

5



1x  
6343067



1x  
4529236



1x  
6234695



1x  
6359865



1x  
6279875



1x  
6195325



1x  
6280097



2x  
393726



2x  
393826



1x  
6329698



1x  
6000650



1x  
6093525



1x  
4188953



1x  
6306748



2x  
6256058



1x  
6244761



1x  
6273627



1x  
6274740



1x  
6325978



1x  
6325955



3x  
6213778



6x  
6213776



1x  
6429249



3x  
6210399



7x  
6217659



2x  
6342088



2x  
6293302



2x  
6213787



5x  
6396079



2x  
6291782



1x  
6259794



1x  
4624381



1x  
6258352



1x  
6258353



1x  
6264062



1x  
6286831



1x  
6185108



2x  
6092592



1x  
6102906



1x  
6430052



1x  
6424457



1x  
6060795



1x  
6409759



4x  
6194729



1x  
6287856



1x  
6416551



1x  
6196796



2x  
6312460



3x  
4651231



2x  
6223506



1x  
4624086



1x  
6226646



2x  
6424480



1x  
4113917



2x  
6292154



1x  
6291414



1x  
4114084



1x  
6429228



1x  
6416639



1x  
4509897



2x  
6192922



1x  
6430144



1x  
6135191



4x  
6258566

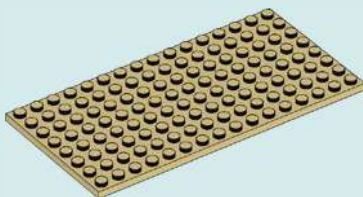

1x  
4609726



1x  
6093494



2x  
6287638



1x  
6099341



4x  
6425367



1x  
6295464



2x  
4159553



1x  
6313600



1x  
6374151



 [LEGO.com/service](https://www.lego.com/service)

YOU COULD

WIN



Scan this QR code or go to  
**LEGO.COM/PRODUCTFEEDBACK**  
and give us your short feedback  
about this LEGO® set for a chance  
to win a cool LEGO prize.

Terms and Conditions apply\*

**DE: Du könntest GEWINNEN.** Es gelten die Teilnahmebedingungen\* **FR: Tu pourrais GAGNER.** Des conditions s'appliquent\* **IT: Potresti VINCERE tu.** Termini e condizioni sono applicabili\* **ES: Puedes GANAR.** Aplican términos y condiciones\* **PT: Poderá GANHAR.** Aplicam-se termos e condições\* **JA: プレゼント付き! 利用規約が適用されます\*** **ZH: 轻松获奖. 条款和条件适用\*** **KO: 상품의 주인이 되어보세요. 소정의 약관이 적용됩니다\*** **RU: Вы можете ВЫИГРАТЬ.** Действуют положения и условия\* **PL: Szansa na WYGRANĄ.** Obowiązują warunki korzystania\* **CS: Máte šanci VYHRÁT.** Platí všeobecné smluvní podmínky\* **SK: Máte šancu VYHRÁŤ.** Platia všeobecné zmluvné podmienky\* **HU: TE IS NYERHETSZ.** Felhasználási feltételek érvényesek\* **RO: Ai putea CÂȘTIGA.** Se aplică termeni și condiții\* **BG: Можете да СПЕЧЕЛИТЕ.** Има определени правила и условия\* **LV: Tu vari LAIMĒT.** Ir spēkā noteikumi un nosacījumi.\* **ET: Sul on võimalus VÕITA.** Kehtivad tingimused\* **LT: Jūs galite LAIMĖTI.** Taikomos sąlygos\*

\*[LEGO.com/productfeedback-terms](https://www.lego.com/productfeedback-terms)