

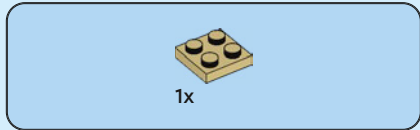

**SUPER
MARIO**™

71420

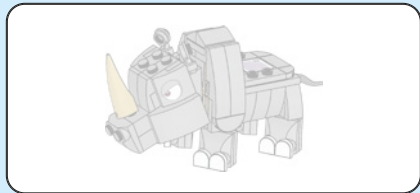



1



2

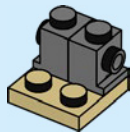



2x

3

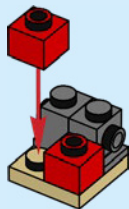

2x

4





1x

5

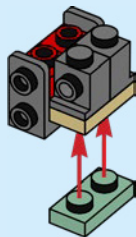

1x



1x

6

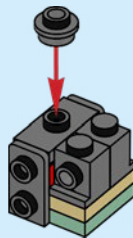

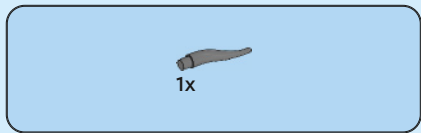

7

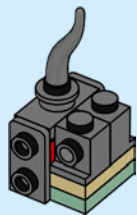

8

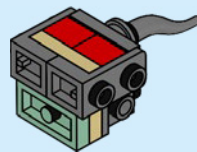

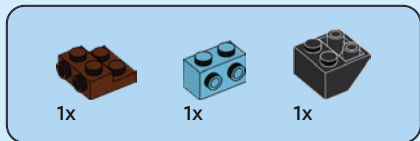

9

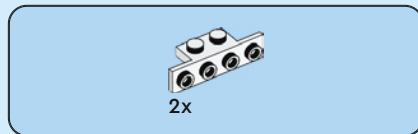
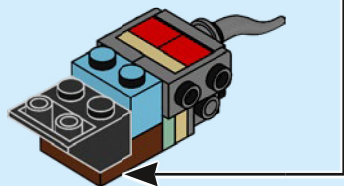
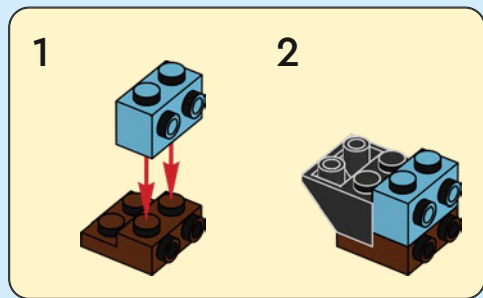

10

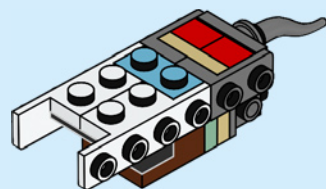

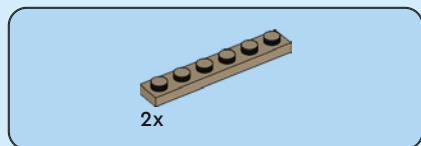

11

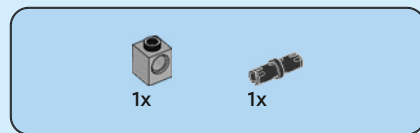
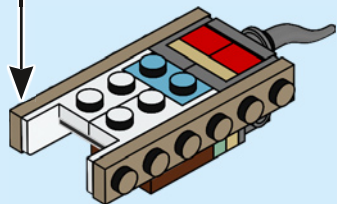
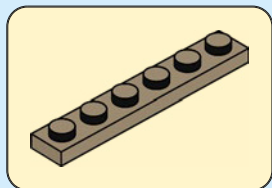

12

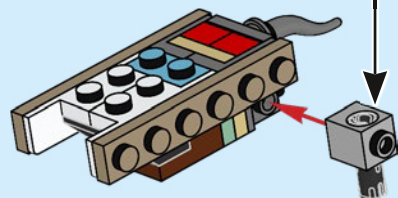
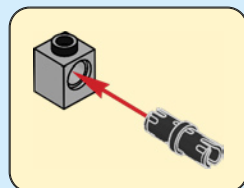



1x

13

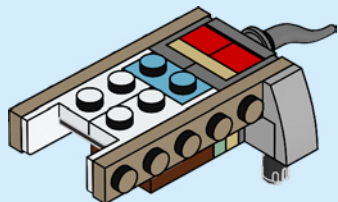

3x

14

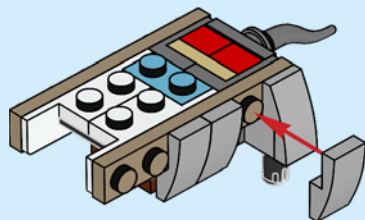



1x



1x

15

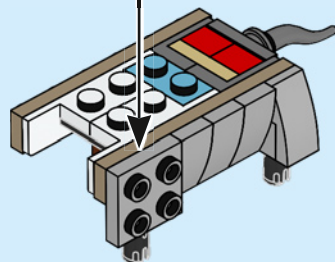
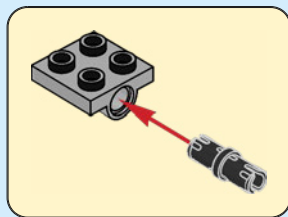



1x



1x

16

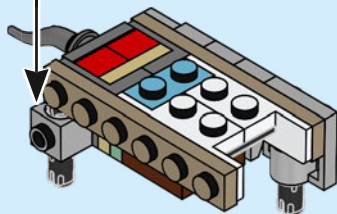
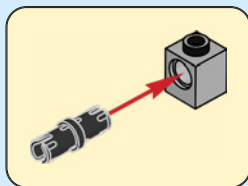

1x

17

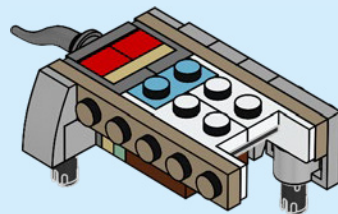



3x

18

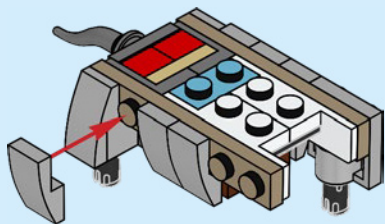

1x



1x

19

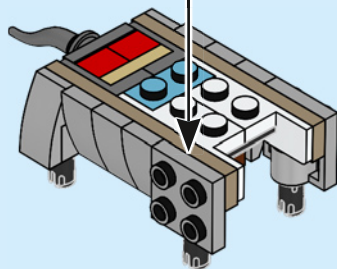
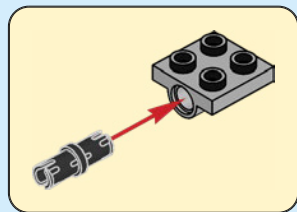

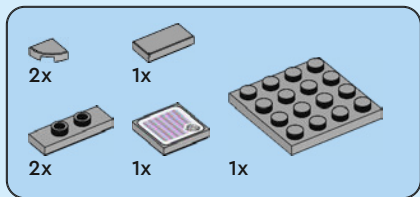

20

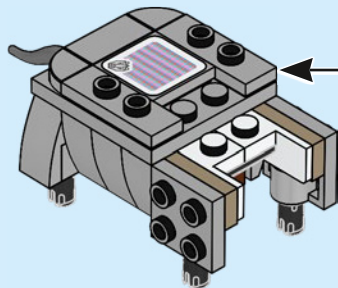
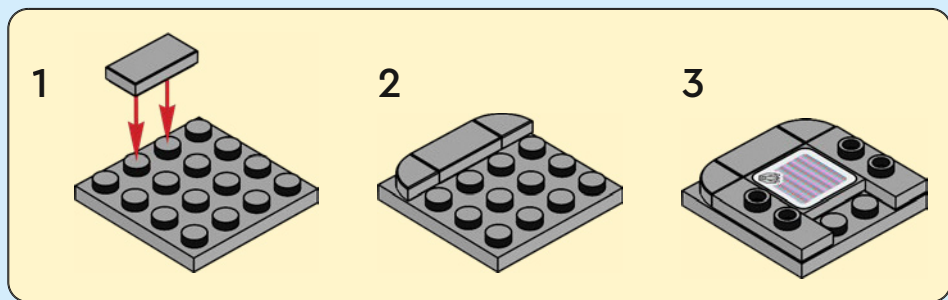

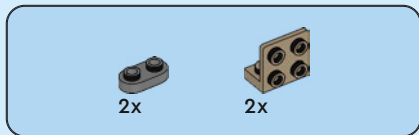

21

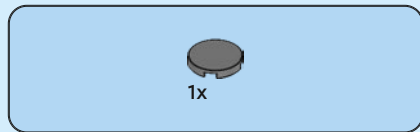
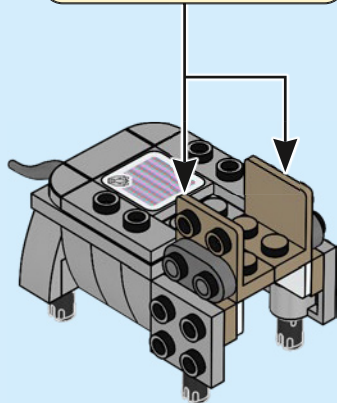
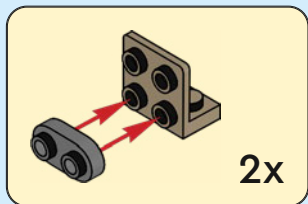

22

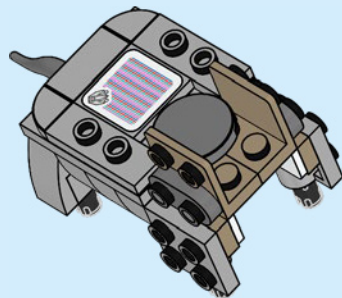



1x

23

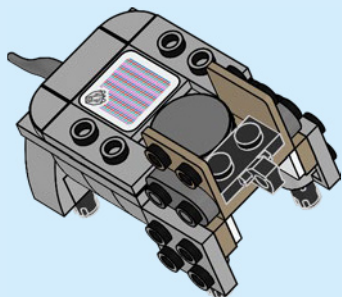

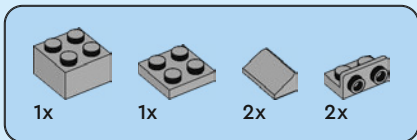

24

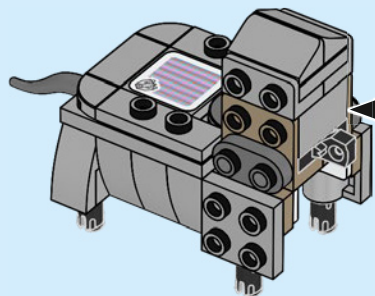
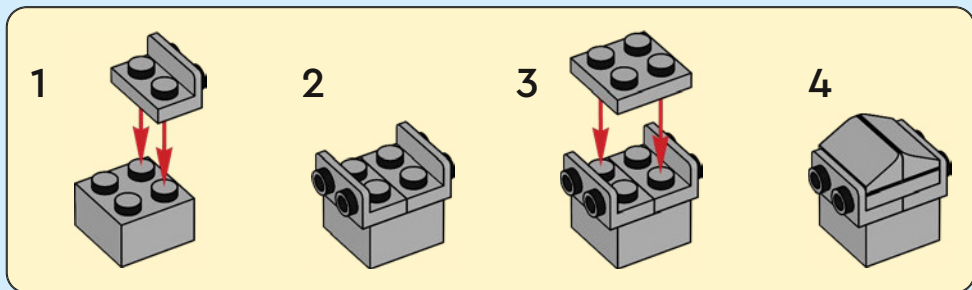

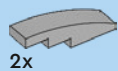

25

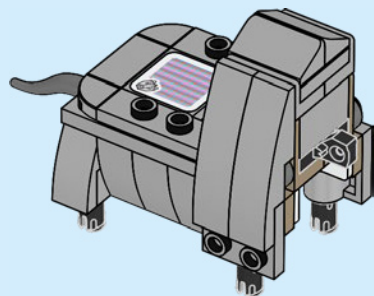

26

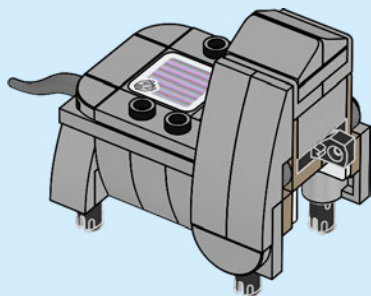



2x

27

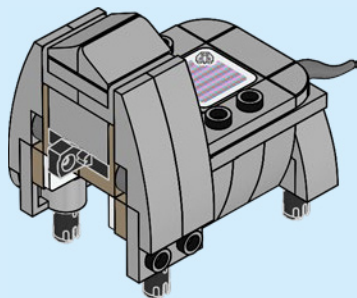

1x

28

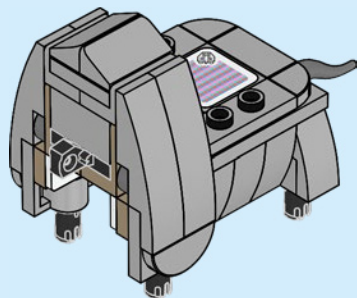

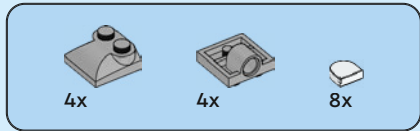

29

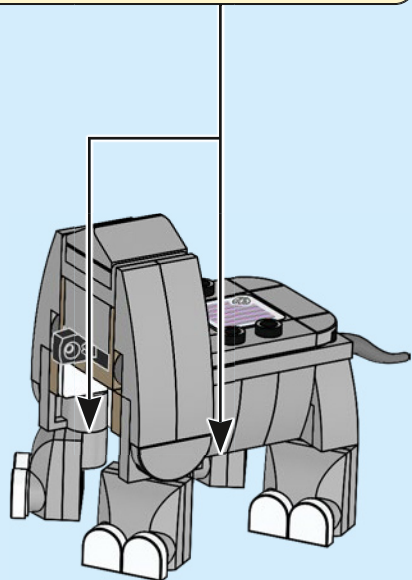
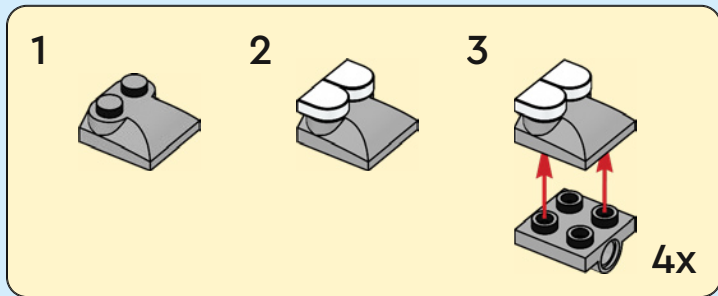

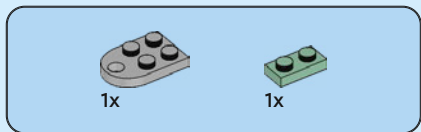

30

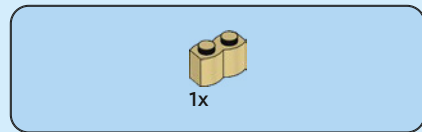
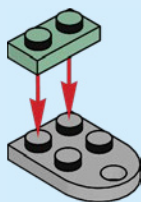

31

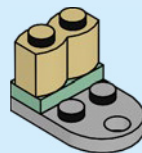



1x



1x

32

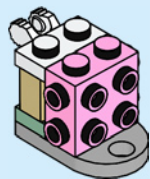

2x

33

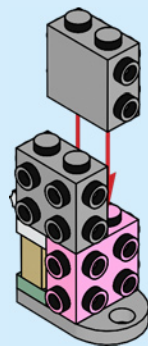

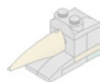

1x

34

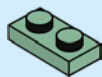

1x

35

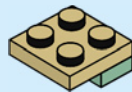



1x

36

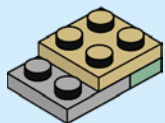

2x

37

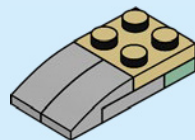

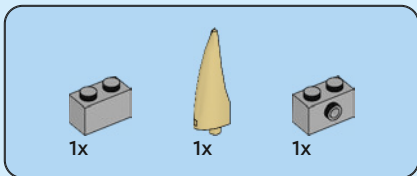

38

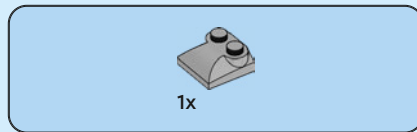
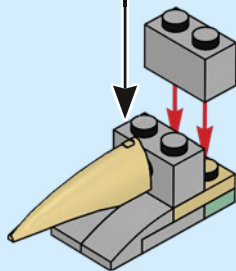
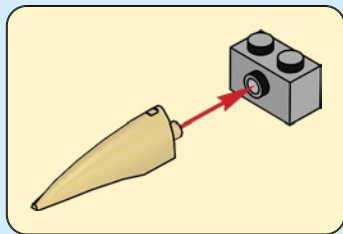

39

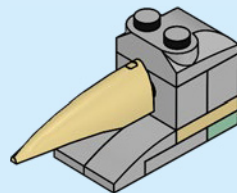

40

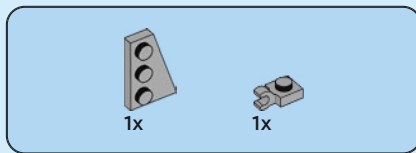
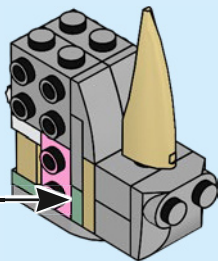

41

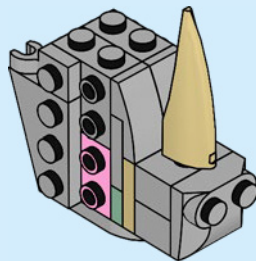

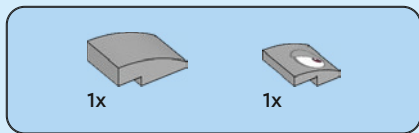

42

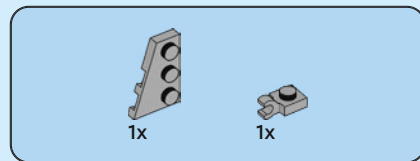
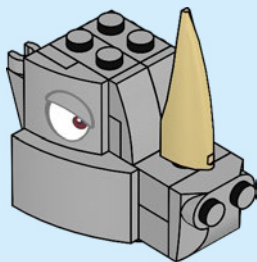

43

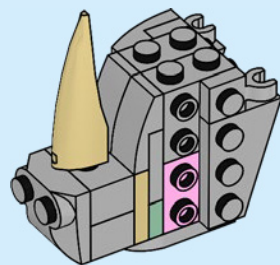



1x



1x

44

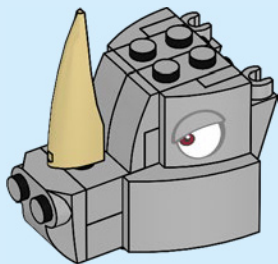

2x

45

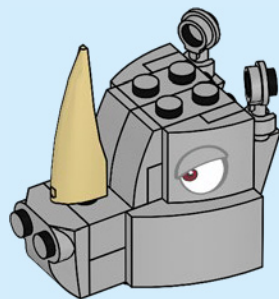

46

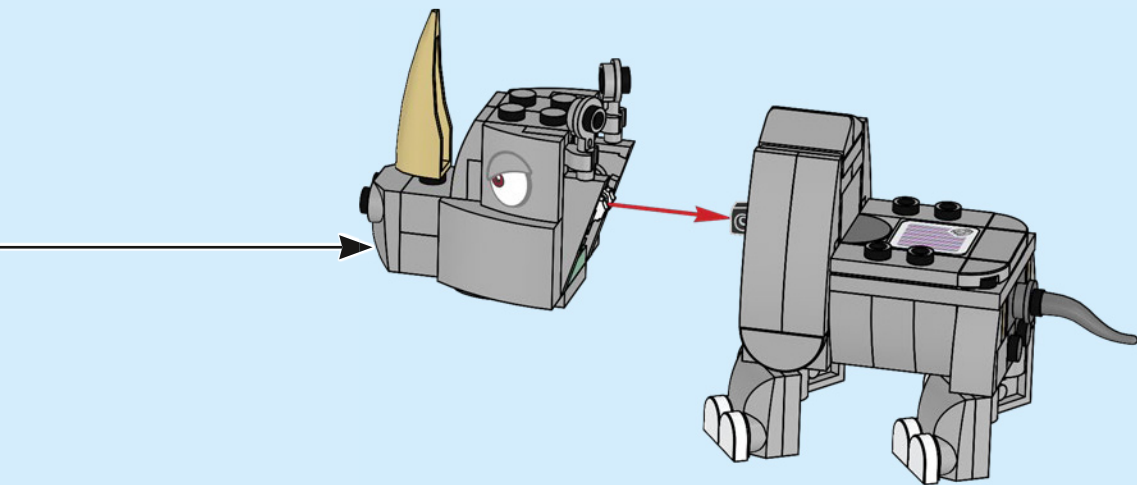

47

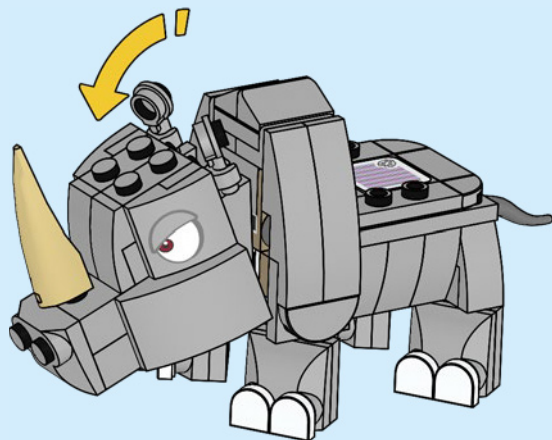

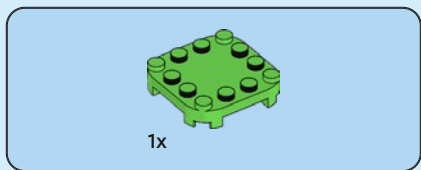
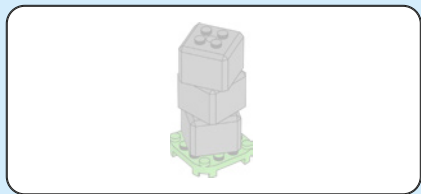

1

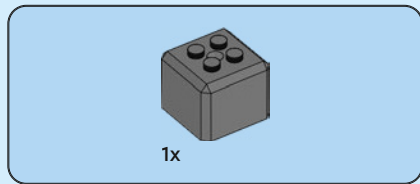
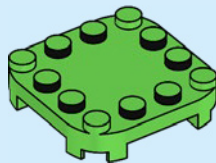

2

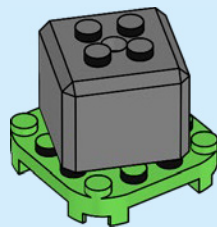



1x

3



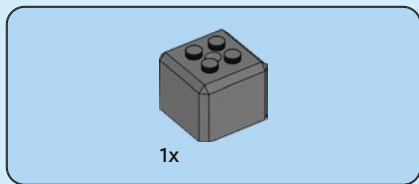

4

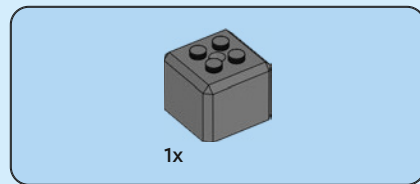
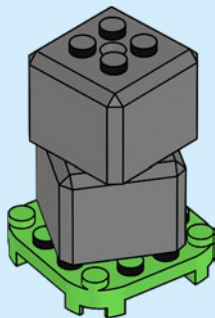

5

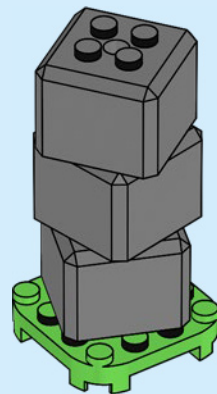

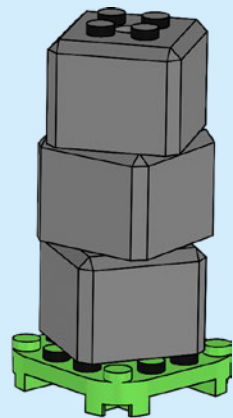
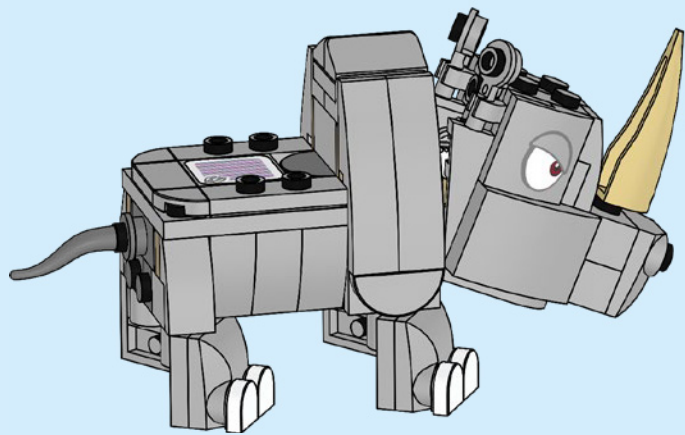

8x
6250591

1x
6266201

2x
6168618

1x
6349519

1x
4218749

2x
4114084

2x
6397571

1x
4114584

1x
6308875

4x
6279875

1x
6266244

1x
6425507

2x
6330148

2x
6015424

3x
4655080

1x
6146301

2x
6176433

2x
6408629

2x
6227897

1x
4211794

2x
6335378

2x
4211535

1x
4211791

2x
4568637

10x
6028813

1x
4211414

1x
4211388

1x
6383177

2x
6004990

6x
6045988

1x
6454703

2x
6301870

2x
4211397

1x
4211387

5x
4494475

1x
6438681

1x
6438680

1x
4211419

1x
4243797

2x
6211969

2x
6132207

4x
6042950

2x
6336390

2x
6221607

1x
6056296

1x
6231765

2x
4211044

1x
6092572

1x
6269080

3x
6452027

1x
6345505

1x
6348142



 [LEGO.com/service](https://www.LEGO.com/service)

LEGO, the LEGO logo and the Brick and Knob configurations are trademarks of the/sont des marques de commerce de/
son marcas registradas de LEGO Group. ©2023 The LEGO Group.
TM & © 2023 Nintendo.



**SUPER
MARIO**™

71420

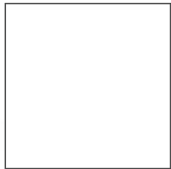



FR
**DONNEZ
OU
RECYCLEZ**



ASSOCIATION

OU



MAGASIN

OU



DÉCHÈTERIE

Adresses sur quefairedemesdechets.fr



LEGO.com/sustainable-packaging

Digital building instruction only

Nur digitale Bauanleitung verfügbar · Instructions de montage numériques uniquement · Presenti solo istruzioni per la costruzione digitale · Solo instrucciones de construcción digitales · Instruções de construção digitais · 仅含数字拼搭说明 · Tylko cyfrowe instrukcje budowania · Pouze digitální návod na stavění · Len digitálny návod na stavanie · Csak digitális építési útmutatóval · Numai instrucțiuni digitale de construcție · Само цифрови инструкции за построяване · Tikai digitāla būvēšanas instrukcija · Ainult digitaalsed ehitusjuhised · Tik skaitmeninės konstravimo instrukcijos



Check for compatibility · Kompatibilität prüfen · Vérifier la compatibilité · Controlla la compatibilità · Comprueba tu compatibilidad · Verificar a compatibilidade · 检查兼容性 · Sprawdź zgodność · Zkontroluj kompatybilitu · Skontroluj si kompatibilitu · Ellenőrizd a kompatibilitást · Verifică compatibilitatea · Проверка за съвместимост · Pārbaudīt saderību · Kontrolli ühilduvust · Patikrinkite suderinamumą

LEGO® Super Mario™ [LEGO.com/devicecheck](https://www.lego.com/devicecheck)

Download the latest app version
Lade die neueste Version der App herunter
Télécharge la dernière version de l'application
Scarica l'ultima versione dell'app
Descarga la última versión de la app
Descarrega a versão mais recente da aplicação
下載最新的应用程序

Pobierz najnowszą wersję aplikacji
Stáhní si najnovější verzi aplikace
Stiahni si najnovšiu verziu aplikácie
Töltsd le az applikáció legújabb verzióját!
Descarcă cea mai recentă versiune a aplicației
Изтеглете най-новата версия на приложението
Lejupielādē lietotnes jaunāko versiju
Laadi alla rakenduse uusim versioon
Atsisiųsk naujausią programėlės versiją

**DOWNLOAD
THE LATEST
APP
VERSION**



2

CONNECT TO UPDATE YOUR INTERACTIVE FIGURE

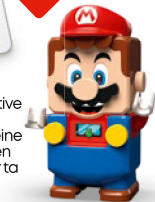
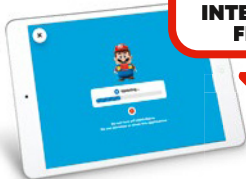

Connect to update your interactive figure

Stell eine Verbindung her, um deine interaktive Figur zu aktualisieren

Connecte-toi pour mettre à jour ta figurine interactive

Connettiti per aggiornare il tuo personaggio interattivo

Conectate a tu figura interactiva para actualizarla

Conecta para actualizar a tua figura interativa

建立连接,更新你的交互式人偶

Połącz się, aby zaktualizować swoją interaktywną figurkę

Připoj se a aktualizuj interaktivní figurku

Pripoj sa a aktualizuj si interaktívnu figurku

Csatlakoztasd az interaktív figurádat a frissítésért!

Conectează-te pentru a-ți actualiza figurina interactivă

Свържете се със своята интерактивна фигура или я актуализирайте

Izveido savienojumu, lai atjauninātu savu interaktīvo figūru

Interaktiivse figuuri värskendamiseks loo ühendus

Prisijunk, kad atnaujintum savo interaktyviąją figurėlę

LEGO.com/super-mario-trouble-shooting-guide

3

ADD SET TO YOUR COLLECTION



Add set to your collection
Füge das Set zu deiner Sammlung hinzu

Ajoute un set à ta collection

Aggiungi il set alla tua collezione

Agrega el set a tu colección

Adiciona o set à tua coleção

用此套装丰富你的系列藏品

Dodaj zestaw do swojej kolekcji

Přidej si set do sbírky

Pridaj si set do zbierky

Add a szettet a gyűjteményedhez!

Adaugā setul la colecția ta

Добавете комплекта към колекцията си

Pievieno komplektu savai kolekcijai

Lisa komplekt oma kolleksiooni

Papildyk rinkiniu savo kolekciją

4

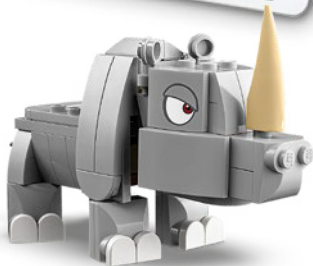

71360 + 71403



71387 + 71403

CONNECT 2 FIGURES FOR TEAM PLAY

2 Figuren für Teamplay-Modus verbinden
 Connecte 2 figurines pour jouer en équipe
 Connetti 2 personaggi per il gioco di squadra
 Conecta 2 figuras para jugar en equipo
 Conecta 2 figuras para jogo em equipa
 连接 2 个人偶进行团队游戏
 Połącz dwie figurki, aby bawić się z drugą osobą
 Připojte 2 figurky pro týmovou hru
 Pripojte 2 figúrky pre tímovú hru
 Csatlakoztass 2 figurát a csapatjátékhoz!
 Conectează 2 figurine pentru joacă în echipă
 Свържете 2 фигури за отборна игра
 Savienojiet 2 figūras, lai spēlētu komandā
 Meeskonnamänguks ühenda kaks figuuri
 Sujunkite 2 figūrēles ir mēgaukitēs komandīnu
 žaidīmu



Starter Course 71360 and/or 71387 and/or 71403 needed
Starterset 71360 und/oder 71387 und/oder 71403 wird
benötigt

Pack(s) de démarrage 71360 et/ou 71387 et/ou 71403
nécessaire(s)

Starter Pack 71360 e/o 71387 e/o 71403 necessari
Se necesita el Pack Inicial 71360 y/o 71387 y/o 71403
Necessita do Pack Inicial 71360 e/ou 71387 e/ou 71403
スターセット (71360/71387/71403 のいずれか)
が必要です

需要入门套组 71360 和/或 71387 和/或 71403
스타터팩 71360, 71387 또는 71403 이 필요합니다



Для игры необходимы Стартовые наборы (арт. 71360 и/или 71387, и/или 71403)
 Potrzebne są zestawy startowe 71360, 71387 i/lub 71403
 Je zapotřebí startovací set 71360 nebo 71387 nebo 71403
 Je potrebný štartovací set 71360 a/alebo 71387 a/alebo 71403
 A 71360-as és/vagy a 71387-es és/vagy a 71403-as Kezdőpálya szükséges

Este nevoie de Setul de bază 71360 și/sau 71387 și/sau 71403
 Нужни са начална писта 71360 и/или 71387 и/или 71403
 Nepieciešams sākuma maršruta komplekts 71360 un/vai 71387, un/vai 71403

Vaja on alustusrada 71360 ja/või 71387 ja/või 71403
 Reikalingas pradinis rinkinys 71360 ir (arba) 71387 ir (arba) 71403



YOU COULD **WIN**



Scan this QR code or go to
LEGO.COM/PRODUCTFEEDBACK and give us
your short feedback about this LEGO® set
for a chance to win a cool LEGO prize.

Terms and Conditions apply*

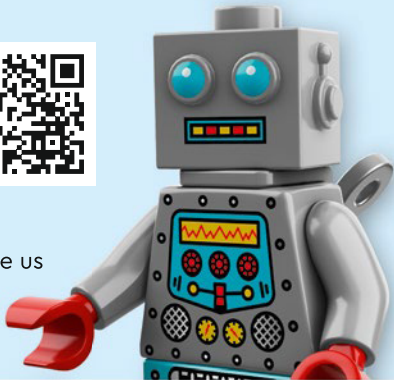

EN: YOU COULD WIN. Terms and Conditions apply* **DE: Du könntest GEWINNEN.** Es gelten die Teilnahmebedingungen* **FR: Tu pourrais GAGNER.** Des conditions s'appliquent* **IT: Potresti VINCERE tu.** Termini e condizioni sono applicabili* **ES: Puedes GANAR.** Aplican términos y condiciones* **PT: Poderá GANHAR.** Aplicam-se termos e condições* **ZH: 轻松获奖. 条款和条件适用*** **PL: Szansa na WYGRANĄ.** Obowiązują warunki korzystania* **CS: Máte šanci VYHRÁT.** Platí všeobecné smluvní podmínky* **SK: Máte šancu VYHRÁŤ.** Platia všeobecné zmluvné podmienky* **HU: TE IS NYERHETSZ.** Felhasználási feltételek érvényesek* **RO: Ai putea CÂȘTIGA.** Se aplică termeni și condiții* **BG: Можете да СПЕЧЕЛИТЕ.** Има определени правила и условия* **LV: Tu vari LAIMĒT.** Ir spēkā noteikumi un nosacījumi.* **ET: Sul on võimalus VÕITA.** Kehtivad tingimused* **LT: Jūs galite LAIMĖTI.** Taikomos sąlygos*

*[LEGO.com/productfeedback-terms](https://www.lego.com/productfeedback-terms)

LEGO, the LEGO logo and the Brick and Knob configurations are trademarks and/or copyrights of the LEGO Group.

©2023 The LEGO Group. 6489911

TM & © 2023 Nintendo.

[LEGO.com/service](https://www.lego.com/service)