

Tefal®

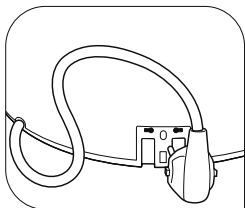

www.tefal.com

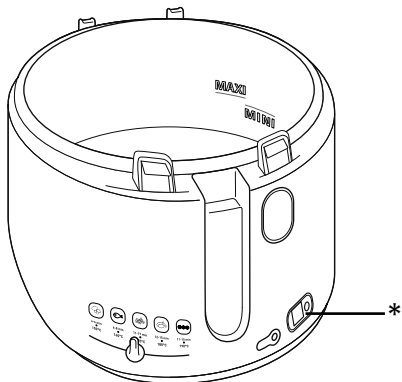
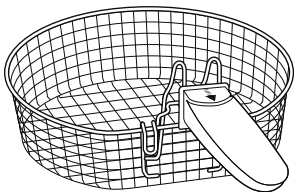
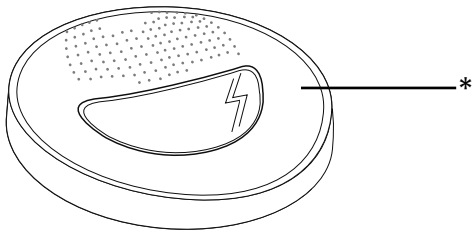

1

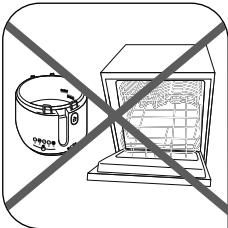
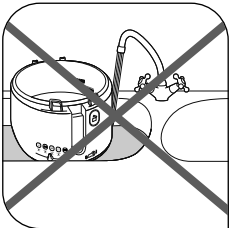
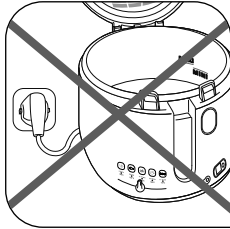
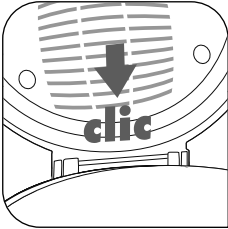
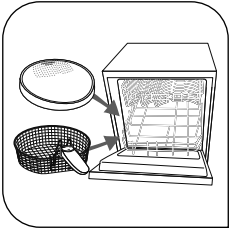
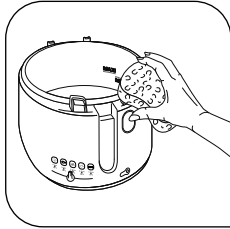
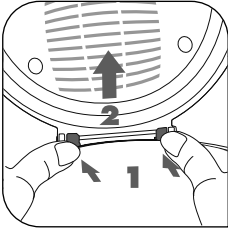
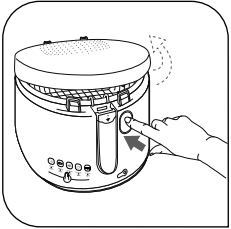
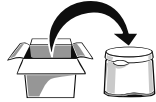

* selon modèle, depending on model, je nach Modell, niet op alle modellen aanwezig, a seconda del modello, según modelo, conforme o modelo, bazı modellerde, afhankelijk af model, beroende på modell, kun på noen modeller, mallista riippuen, -ύλογο με το μόντέλο, в зависимости от модели, w zależności od modelu, podle modelu, podľ'a modelu, modelltöl fuggöen, според модела, حسب الموديل

3

2



 Min. 1,9l
Max. 2,1l

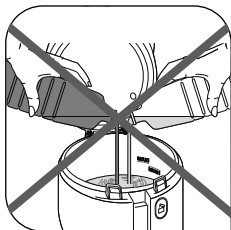
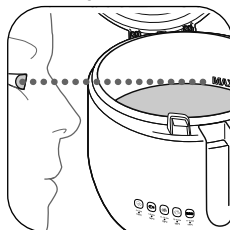
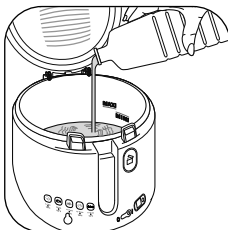

 Min. 1660 g
Max. 1910 g

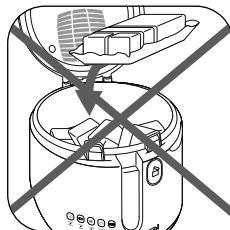
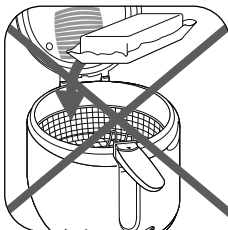
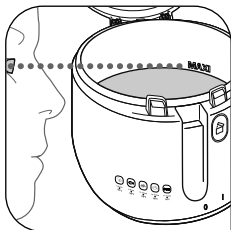
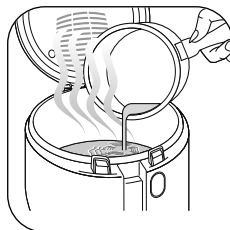
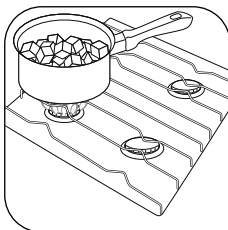

4



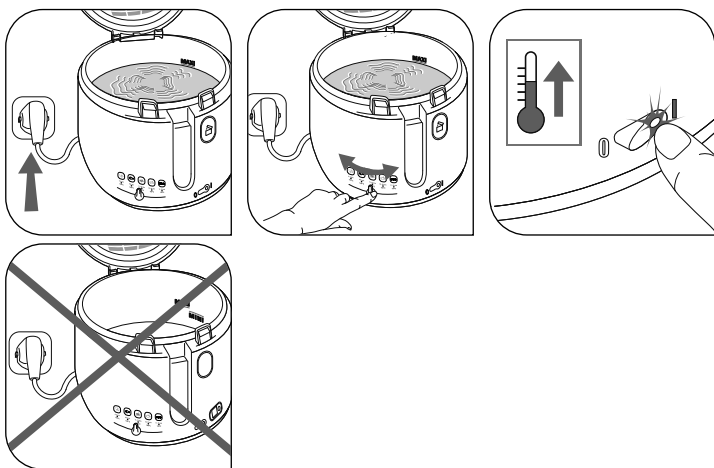

3

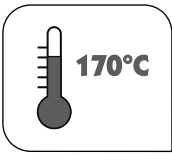

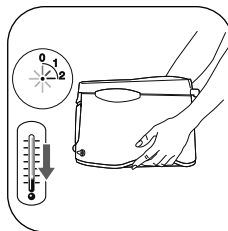
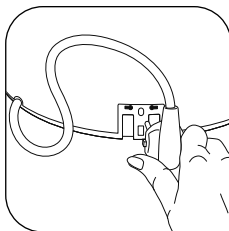
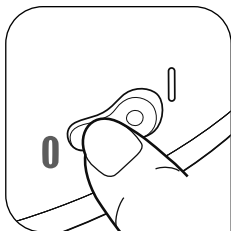
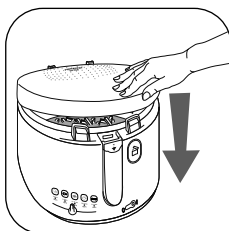
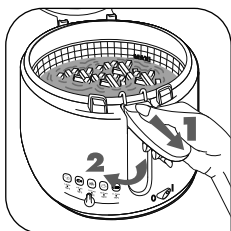
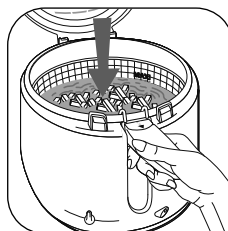
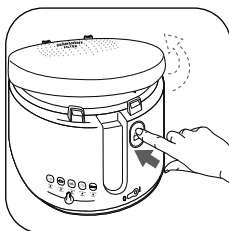
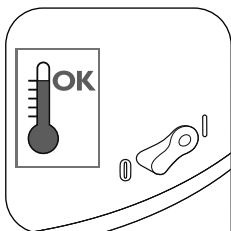
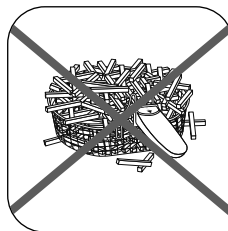
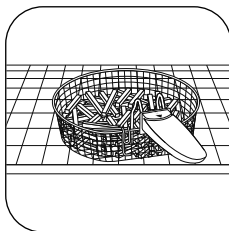
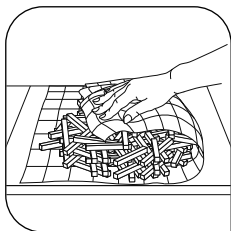



4

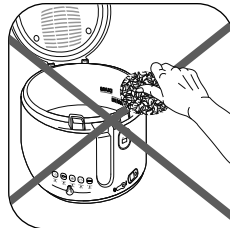
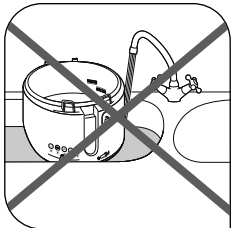
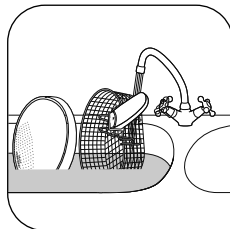
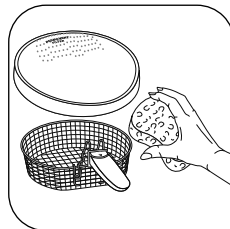
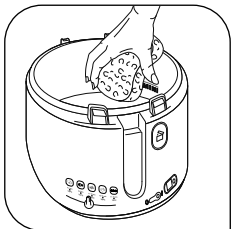
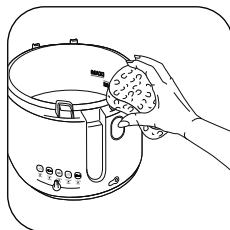
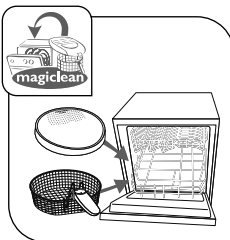
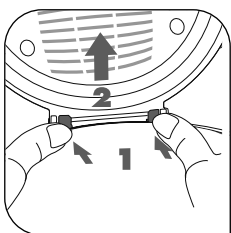
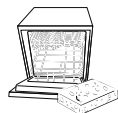

7

5



	Nb			
		600 g	170°C	+/- 11 - 16 min.
	2		180°C	+/- 14 - 16 min.
	1 - 2		170°C	+/- 6 - 8 min.
	6		170°C	+/- 3 - 4 min.
		200 g	MINI	+/- 5 - 7 min.
	10 - 12		180°C	+/- 11 - 13 min.
	4		180°C	+/- 5 - 6 min.

* * *	Nb			
		450 g	170°C	+/- 9 - 13 min.
	2	300 g	190°C	+/- 5 - 7 min.
	2		190°C	+/- 14 - 15 min.
	16	275 g	190°C	+/- 4 - 5 min.
	12	180 g	190°C	+/- 3 - 4 min.



Wir empfehlen Ihnen folgende Hinweise zu beachten:

- Reduzieren Sie die Frittierertemperaturen auf 170°C, insbesondere bei stärkehaltigen Produkten (z.B. Pommes Frites).
- Überwachen Sie den Frittiervorgang: Essen Sie nur gold-braun frittierte Produkte. Vermeiden Sie zu dunkel frittierte Nahrungsmittel.
- Filtrieren Sie das Öl nach jedem Frittierdurchgang, um evtl. Speisereste zu entfernen. Wechseln Sie das Öl regelmäßig.
- Essen Sie abwechslungsreiche, ausgewogene Kost mit viel Gemüse und Obst.

Für ein gesundes und schnelles Frittieren empfehlen wir Ihnen die Füllmenge von Pommes Frites auf einen halben Korb pro Frittierdurchgang zu begrenzen.

8

www.tefal.com

Ref. NC00124341 - 05/14